



**30HXC 080-375**

**30GX 082-358**

**Screw Compressor**

**Water-Cooled Liquid Chillers and**

**Air-Cooled Liquid Chillers**

30HXC Nominal cooling capacity 290-1325 kW

30GX Nominal cooling capacity 285-1205 kW

50 Hz



**GLOBAL CHILLER**



**Installation, operation and maintenance instructions**



Quality Management System Approval

The cover photograph is for illustrative purposes only and is not part of any offer for sale or contract.

---

# List of contents

---

<b>1 - INTRODUCTION .....</b>	<b>4</b>	<b>12 - ELECTRICAL CHARACTERISTICS .....</b>	<b>23</b>
		12.1 - 30HXC .....	23
<b>2 - SAFETY CONSIDERATIONS .....</b>	<b>4</b>	12.2 - 30GX .....	23
		12.3 - 30HXC/GX .....	23
<b>3 - DIMENSIONS, CLEARANCES, WEIGHT DISTRIBUTION .....</b>	<b>5</b>	<b>13 - RECOMMENDED WIRE SECTIONS .....</b>	<b>24</b>
3.1 - 30HXC 080-190 .....	5	13.1 - Field control wiring .....	25
3.2 - 30HXC 200-375 .....	6		
3.3 - 30GX 082-182 .....	7	<b>14 - MAJOR SYSTEM COMPONENTS AND OPERATION DATA .....</b>	<b>26</b>
3.4 - 30GX 207-358 .....	8	14.1 - Geared twin screw compressor .....	26
<b>4 - PHYSICAL DATA 30HXC .....</b>	<b>9</b>	14.2 - Evaporator .....	26
<b>5 - ELECTRICAL DATA 30HXC .....</b>	<b>9</b>	14.3 - Condenser and oil separator (30HXC) .....	26
<b>6 - ELECTRICAL DATA FOR UNITS WITH HIGH CONDENSING TEMPERATURES .....</b>	<b>11</b>	14.4 - Oil separator (30GX) .....	26
<b>7 - PHYSICAL DATA 30GX .....</b>	<b>12</b>	14.5 - Electronic Expansion Device (EXD) .....	26
<b>8 - ELECTRICAL DATA 30GX .....</b>	<b>12</b>	14.6 - Economizer .....	26
<b>9 - APPLICATION DATA .....</b>	<b>13</b>	14.7 - Oil pumps .....	27
9.1 - Unit operating range .....	13	14.8 - Motor cooling valves .....	27
9.2 - Minimum chilled water flow .....	13	14.9 - Sensors .....	27
9.3 - Maximum chilled water flow .....	13	14.10 - Thermistors .....	27
9.4 - Variable flow evaporator .....	14	14.11 - 30GX fan arrangement .....	28
9.5 - System minimum water volume .....	14		
9.6 - Cooler flow rate (l/s) .....	14	<b>15 - MAINTENANCE .....</b>	<b>29</b>
9.7 - Condenser flow rate (l/s) .....	14	15.1 - Refrigerant charging - adding charge .....	29
9.8 - Evaporator pressure drop curve .....	15	15.2 - Indication of low charge on a 30HXC system .....	29
9.9 - Condenser pressure drop curve .....	16	15.3 - Pressure transducers .....	30
9.10 - Flow controllers .....	17	15.4 - Oil charging - low oil recharging .....	30
		15.5 - Integral oil filter change .....	30
<b>10 - INSTALLATION .....</b>	<b>17</b>	15.6 - Filter change-out schedule .....	30
10.1 - Check equipment received .....	17	15.7 - Filter change-out procedure .....	30
10.2 - Moving and siting the unit .....	17	15.8 - Compressor replacement .....	30
		<b>16 - START-UP CHECKLIST FOR 30HXC/GX LIQUID CHILLERS .....</b>	<b>32</b>
<b>11 - LIFTING INSTRUCTIONS .....</b>	<b>18</b>		
11.1 - 30HXC 080-190 .....	18		
11.2 - 30HXC 200-285 .....	19		
11.3 - 30HXC 310-375 .....	19		
11.4 - 30GX 082-162 .....	20		
11.5 - 30GX 182 .....	20		
11.6 - 30GX 207-267 .....	21		
11.7 - 30GX 298-358 .....	21		
11.8 - Piping connections .....	22		

## 1 - INTRODUCTION

Prior to initial start-up of the 30HXC and 30GX unit, those involved in the start-up, operation, and maintenance should be thoroughly familiar with these instructions and other necessary job data. This book provides an overview so that you may become familiar with the control system before performing start-up procedures. Procedures in this manual are arranged in the sequence required for proper machine start-up and operation.

## 2 - SAFETY CONSIDERATIONS

30HXC and 30GX liquid chillers are designed to provide safe and reliable service when operated within design specifications. When operating this equipment, use good judgment and safety precautions to avoid damage to equipment and property or injury to personnel.

Be sure you understand and follow the procedures and safety precautions contained in the machine instructions as well as those listed in this guide.

### **DANGER**

**DO NOT VENT** refrigerant relief valves within a building. Outlet from relief valve must be vented outdoors. The accumulation of refrigerant in an enclosed space can displace oxygen and cause asphyxiation or explosions.

**PROVIDE** adequate ventilation, especially for enclosed and low overhead spaces. Inhalation of high concentrations of vapor is harmful and may cause heart irregularities, unconsciousness, or death. Vapor is heavier than air and reduces the amount of oxygen available for breathing. Product causes eye and skin irritation. Decomposition products are hazardous.

**DO NOT USE OXYGEN** to purge lines or to pressurize a machine for any purpose. Oxygen gas reacts violently with oil, grease, and other common substances.

**NEVER EXCEED** specified test pressures, **VERIFY** the allowable test pressure by checking the instruction literature and the design pressures on the equipment nameplate.

**DO NOT USE** air for leak testing. Use only refrigerant or dry nitrogen.

**DO NOT VALVE OFF** any safety device.

**BE SURE** that all pressure relief devices are properly installed before operating any machine.

### **WARNING**

**DO NOT WELD OR FLAMECUT** any refrigerant line or vessel until all refrigerant (liquid and vapor) has been removed from chiller. Traces of vapor should be displaced with dry air nitrogen and the work area should be well ventilated. Refrigerant in contact with an open flame produces toxic gases.

**DO NOT** work on energized equipment unless you are a skilled electrician.

**DO NOT WORK ON** electrical components, including control panels, switches, relays etc, until you are sure **ALL POWER IS OFF** and residual voltage can leak from capacitors or solid state components.

**LOCK OPEN AND TAG** electrical circuits during servicing. **IF WORK IS INTERRUPTED**, check that all circuits are de-energized before resuming work.

**DO NOT** siphon refrigerant.

**AVOID SPILLING** liquid refrigerant on skin or getting it into the eyes. **USE SAFETY GOGGLES**. Wash any spills from the skin with soap and water. If liquid refrigerant enters the eyes, **IMMEDIATELY FLUSH EYES** with water and consult a physician.

**NEVER APPLY** an open flame or live steam to refrigerant container. Dangerous overpressure can result. If it is necessary to heat refrigerant, use only warm water.

**DO NOT REUSE** disposable (non-returnable) cylinders or attempt to refill them. It is **DANGEROUS AND ILLEGAL**. When cylinders are emptied, evacuate remaining gas pressure, loosen the collar and unscrew and discard the valve stem. **DO NOT INCINERATE**.

**CHECK THE REFRIGERANT TYPE** before adding refrigerant to the machine. The introduction of the wrong refrigerant can cause damage or malfunction to this machine.

**DO NOT ATTEMPT TO REMOVE** fittings, components, etc., while machine is under pressure or while machine is running. Be sure pressure is at 0 kPa before breaking refrigerant connection.

**CAREFULLY INSPECT** all relief devices, **AT LEAST ONCE A YEAR**. If machine operates in a corrosive atmosphere, inspect the devices at more frequent intervals.

**DO NOT ATTEMPT TO REPAIR OR RECONDITION** any relief device when corrosion or build-up of foreign material (rust, dirt, scale, etc.) is found within the valve body or mechanism. Replace the device.

**DO NOT** install relief devices in series or backwards.

### **CAUTION**

**DO NOT STEP** on refrigerant lines. Broken lines can whip about and release refrigerant, causing personal injury.

**DO NOT** climb over a machine. Use platform, or staging.

**USE MECHANICAL EQUIPMENT** (crane, hoist, etc.) to lift or move heavy components. Even if components are light, use mechanical equipment when there is a risk of slipping or losing your balance.

**BE AWARE** that certain automatic start arrangements **CAN ENGAGE TOWER FAN, OR PUMPS**. Open the disconnect ahead of the tower fans, or pumps.

**USE** only repair or replacement parts that meet the code requirements of the original equipment.

**DO NOT VENT OR DRAIN** water boxes containing industrial brines, without the permission of a competent body.

**DO NOT LOOSEN** water box bolts until the water box has been completely drained.

**DO NOT LOOSEN** a packing gland nut before checking that the nut has a positive thread engagement.

**PERIODICALLY INSPECT** all valves, fittings, and piping for corrosion, rust, leaks, or damage.

**PROVIDE A DRAIN** connection in the vent line near each pressure relief device to prevent a build-up of condensate or rain water.

### 3 - DIMENSIONS, CLEARANCES, WEIGHT DISTRIBUTION

#### 3.1 - 30HXC 080-190

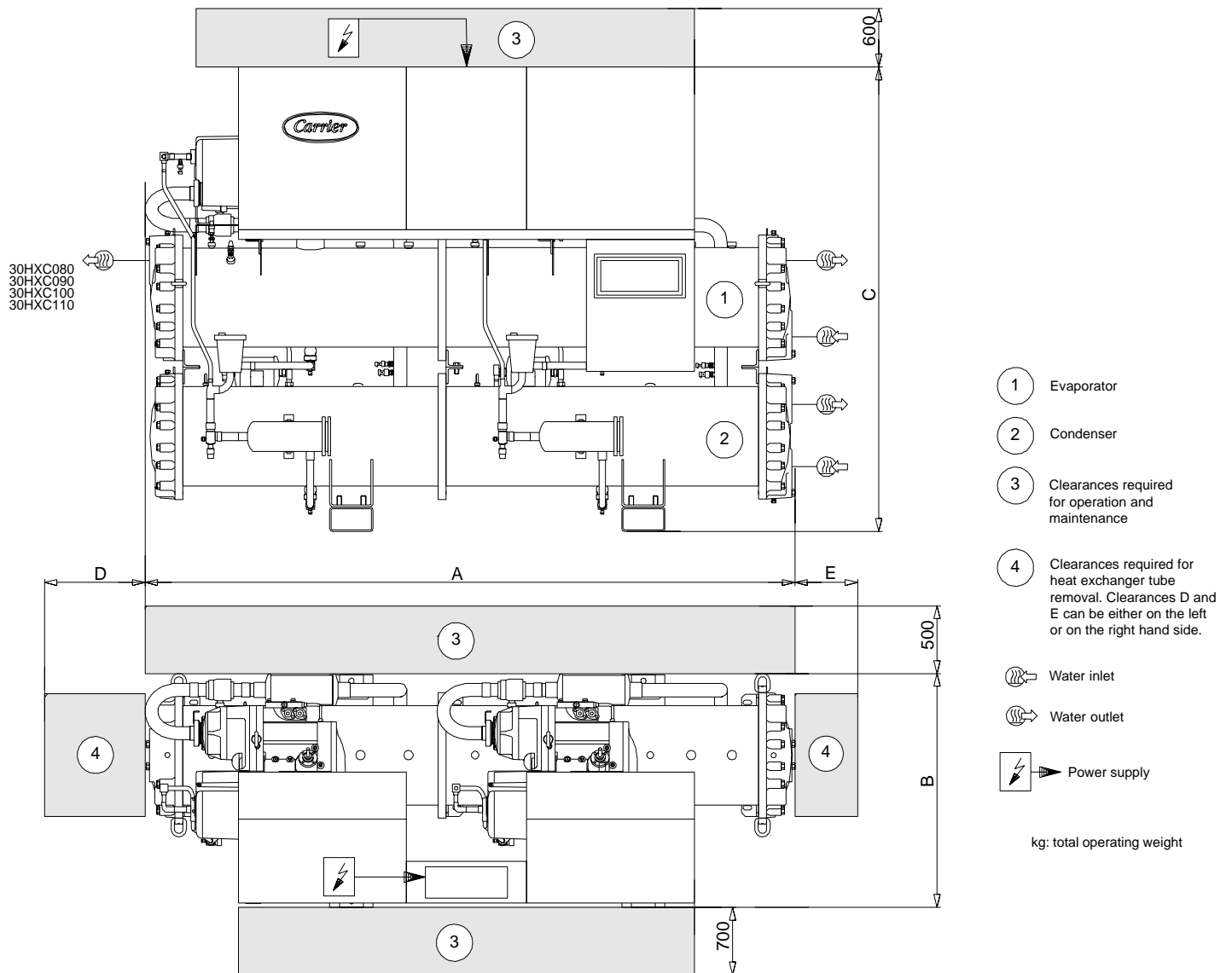

	A mm	B mm	C mm	D mm	E mm	kg
30HXC080						2447
30HXC090	2705	950	1850	2360	1000	2462
30HXC100						2504
30HXC110	2705	950	1900	2360	1000	2650
30HXC120						2846
30HXC130	3535	950	1875	3220	1000	2861
30HXC140						2956
30HXC155						2971
30HXC175	3550	950	2000	3220	1000	3283
30HXC190						3438

NOTE: Refer to the certified dimensional drawings supplied with the unit, when designing an installation.

### 3 - DIMENSIONS, CLEARANCES, WEIGHT DISTRIBUTION (CONT.)

#### 3.2 - 30HXC 200-375

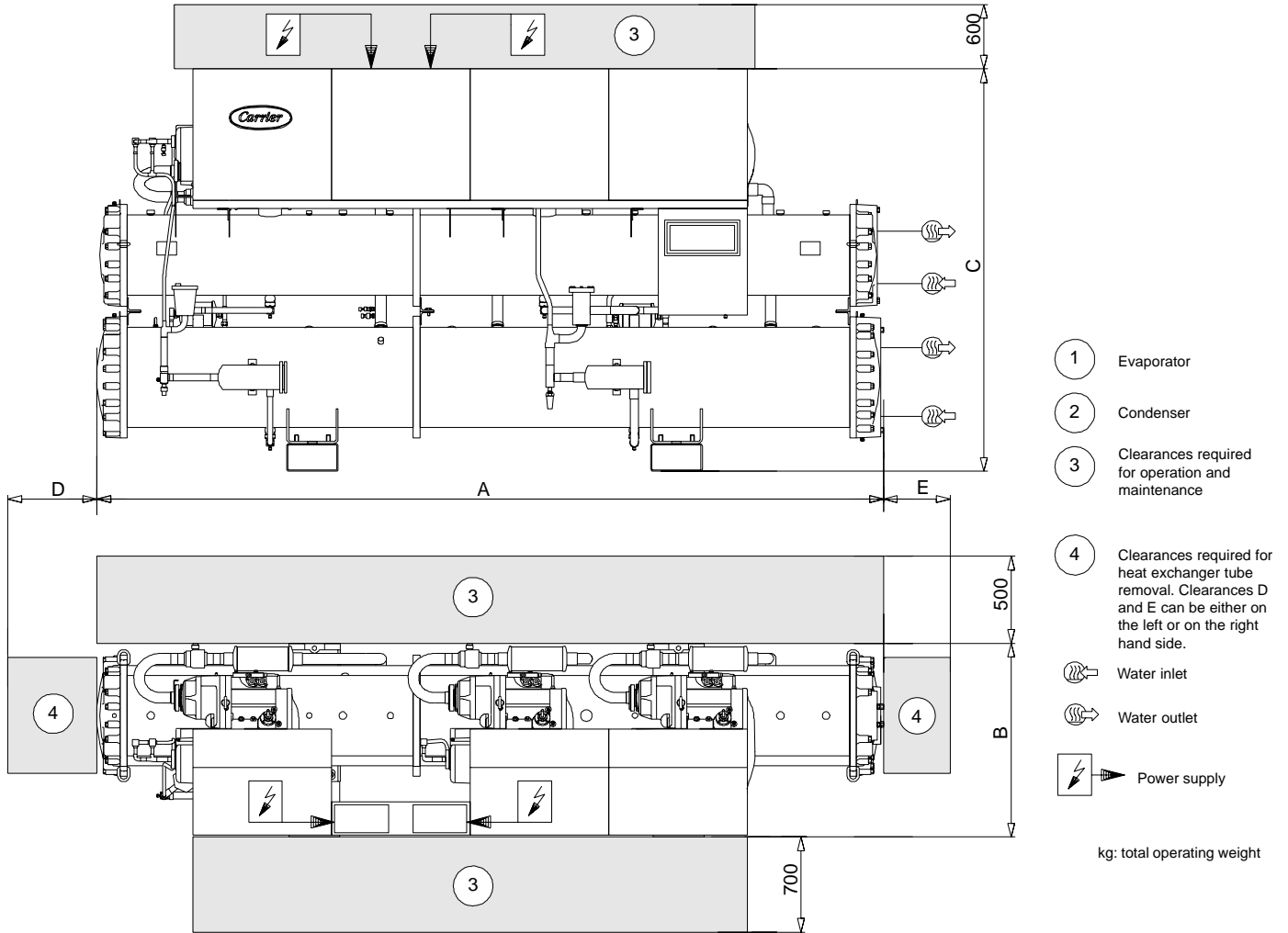

	A mm	B mm	C mm	D mm	E mm	kg
30HXC200	3975	980	2035	3620	1000	4090
30HXC230						4705
30HXC260	3995	980	2116	3620	1000	4815
30HXC285						4985
30HXC310						5760
30HXC345	4490	980	2163	4120	1000	5870
30HXC375						6105

NOTE: Refer to the certified dimensional drawings supplied with the unit, when designing an installation.

### 3 - DIMENSIONS, CLEARANCES, WEIGHT DISTRIBUTION (CONT.)

#### 3.3 - 30GX 082-182

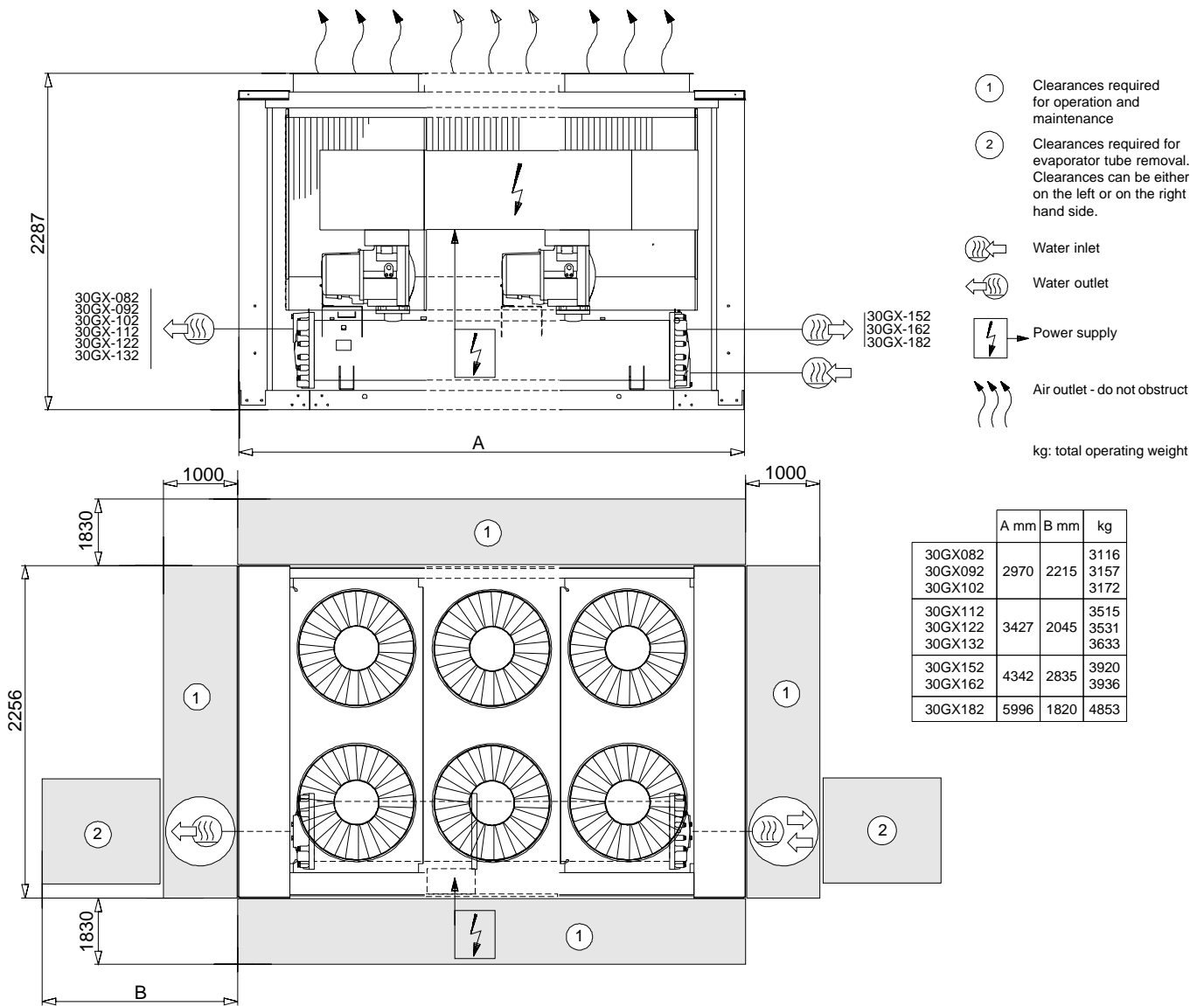

#### Multiple chiller installation (see note 2)

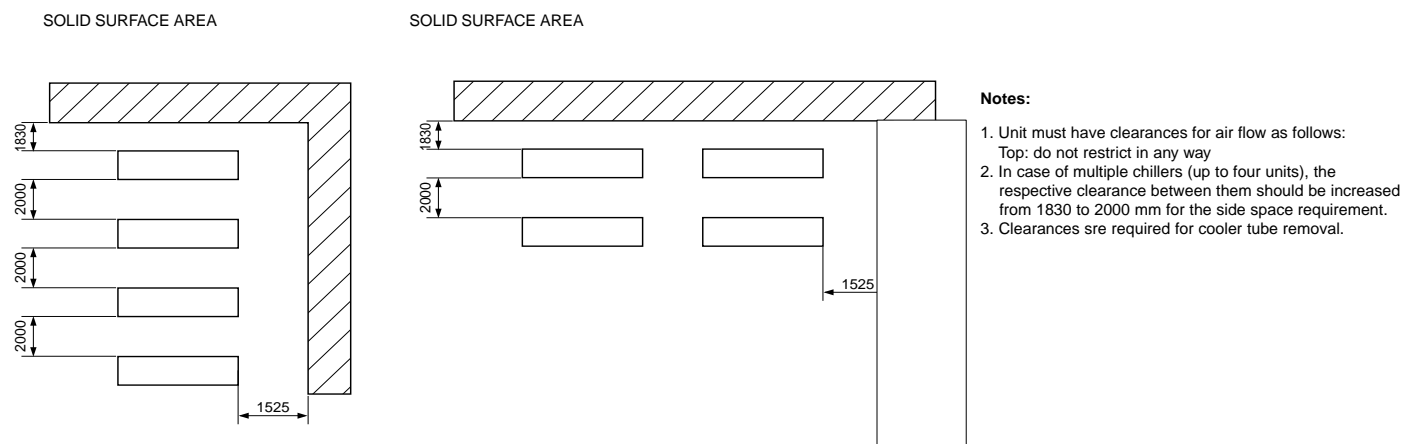

NOTE: Refer to the certified dimensional drawings supplied with the unit, when designing an installation.

### 3 - DIMENSIONS, CLEARANCES, WEIGHT DISTRIBUTION (CONT.)

#### 3.4 - 30GX 207-358

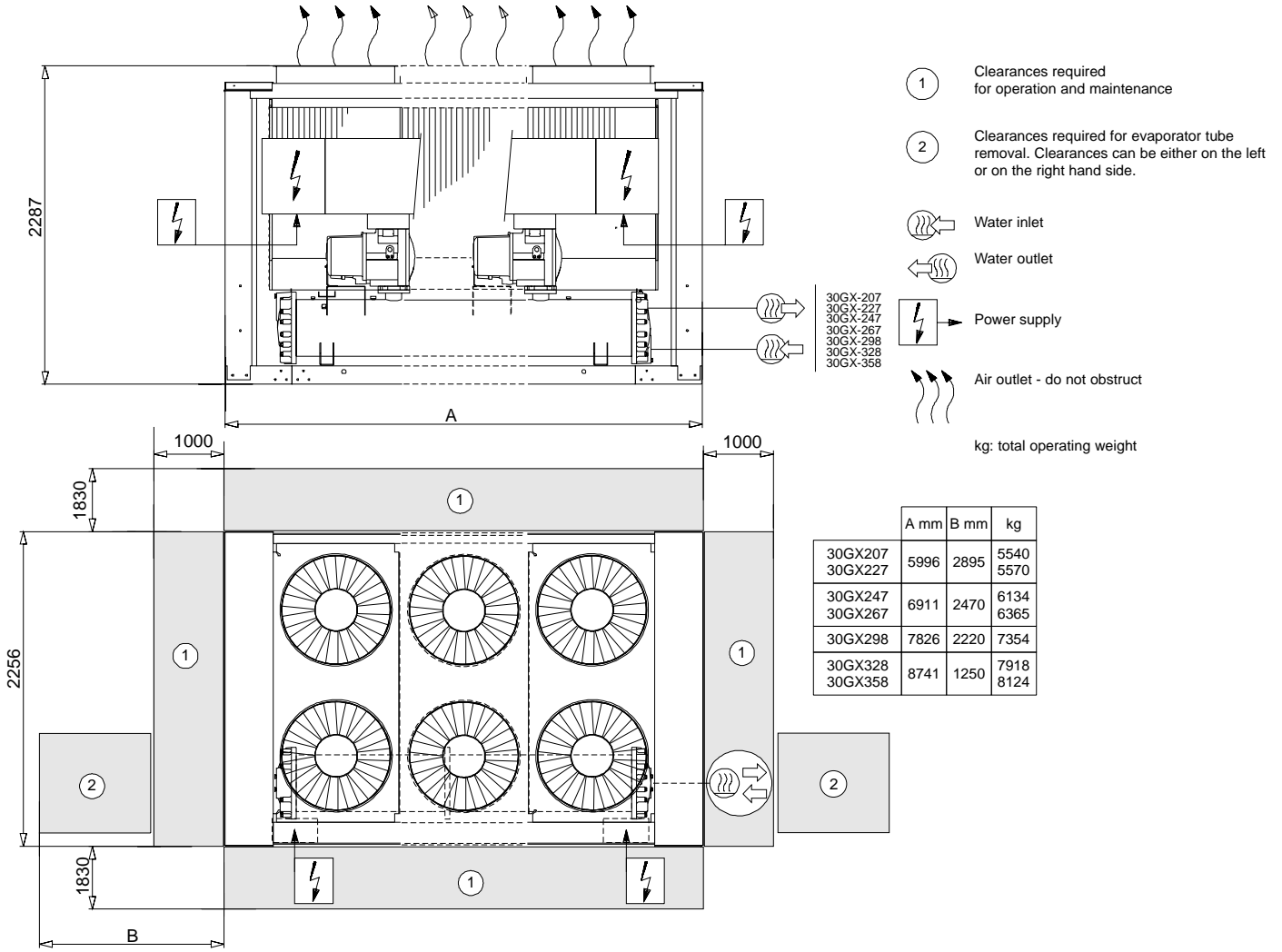

#### Multiple chiller installation (see note 2)

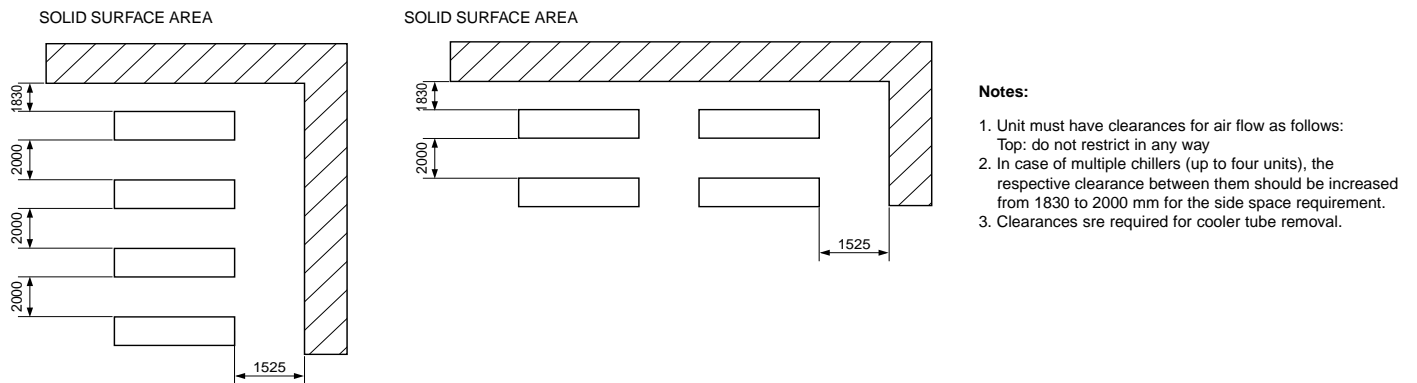

NOTE: Refer to the certified dimensional drawings supplied with the unit, when designing an installation.





## Compressors

Reference	Size	I nom.	MHA	LRA	LRA (Y)	LRA (S) 1 cp.	LRA (S) 2 cp.
06NW2146S7N	39	48	69	344	109	125	-
06NW2174S7N	46	58	83	423	134	154	-
06NW2209S7N	56	71	101	506	160	260	350
06NW2250S7N	66	87	120	605	191	330	400
06NW2300S5N	80	104	144	715	226	370	420
06NW2300S5E	80+	111	165	856	270	385	460

### Legend:

- 06NW - Compressor for water-cooled units
- N - Non-economized compressor
- E - Economized compressor
- INOM - Average current draw of the compressor at Eurovent conditions
- MHA - Must hold amperes (maximum operating current) at 360 V
- LRA - Locked rotor current with across-the-line start
- LRA (Y) - Locked rotor current at reduced current (star/delta start-up mode)
- LRA (S) 1 cp. - Start-up with reduced current with electronic starter (start-up duration 3 seconds max.) for one compressor per circuit
- LRA (S) 2 cp. - Start-up with reduced current with electronic starter (start-up duration 3 seconds max.) for two compressors per circuit

## 6 - ELECTRICAL DATA FOR UNITS WITH HIGH CONDENSING TEMPERATURES 30HXC 150 and 150A Options

30HXC		080	090	100	110	120	130	140	155	175	190	200	230	260	285	310	345	375	
<b>Power circuit</b>																			
Nominal power supply (Un)	V-ph-Hz	400-3-50																	
Voltage range	V	360-440																	
<b>Control circuit supply</b>																			
The control circuit is supplied via the factory-installed transformer																			
<b>Max. power input**</b>																			
	kW	104	117	131	145	159	174	194	211	230	263	271	310	345	395	422	460	526	
Circuit A	kW	-	-	-	-	-	-	-	-	-	-	-	175	195	230	263	211	230	263
Circuit B	kW	-	-	-	-	-	-	-	-	-	-	-	96	115	115	132	211	230	263
<b>Max. current drawn (Un - 10%***</b>																			
	A	190	215	240	265	290	320	355	385	420	480	495	564	630	720	770	840	960	
Circuit A	A	-	-	-	-	-	-	-	-	-	-	-	320	355	420	480	385	420	480
Circuit B	A	-	-	-	-	-	-	-	-	-	-	-	175	210	210	240	385	420	480
<b>Maximum current drawn (Un)***</b>																			
	A	173	195	218	241	264	291	323	350	382	436	450	514	573	655	700	764	873	
Circuit A	A	-	-	-	-	-	-	-	-	-	-	-	291	323	382	436	350	382	436
Circuit B	A	-	-	-	-	-	-	-	-	-	-	-	159	191	191	218	350	382	436
<b>Max. starting current, std. unit (Un)****</b>																			
	A	277	312	335	379	402	435	519	546	578	618	1251	1549	1608	1701	1735	1799	1920	
Circuit A****	A	-	-	-	-	-	-	-	-	-	-	-	1092	1358	1417	1483	1385	1417	1483
Circuit B****	A	-	-	-	-	-	-	-	-	-	-	-	960	1226	1226	1265	1385	1417	1483
<b>Max. starting current/max. current draw ratio, unit</b>																			
		1.61	1.60	1.54	1.57	1.52	1.49	1.61	1.56	1.51	1.42	2.78	3.02	2.81	2.60	2.48	2.36	2.20	
<b>Max. starting current/max. current draw ratio, circuit A</b>																			
		-	-	-	-	-	-	-	-	-	-	-	3.75	4.21	3.71	3.40	3.96	3.71	3.40
<b>Max. starting current/max. current draw ratio, circuit B</b>																			
		-	-	-	-	-	-	-	-	-	-	-	6.03	6.42	6.42	5.80	3.96	3.71	3.40
<b>Max. starting current - reduced current start (Un)****</b>																			
	A	std.	std.	std.	std.	std.	std.	std.	std.	std.	std.	std.	N/A	N/A	N/A	N/A	N/A	N/A	N/A
<b>Three-phase short circuit holding current</b>																			
	kA	25	25	25	25	25	25	25	25	25	25	25	N/A	N/A	N/A	N/A	N/A	N/A	N/A
Circuit A	kA	-	-	-	-	-	-	-	-	-	-	-	25	25	25	25	25	25	25
Circuit B	kA	-	-	-	-	-	-	-	-	-	-	-	15	15	15	15	25	25	25
<b>Customer standby capacity, unit or circ. A, for evaporator water pump connections†</b>																			
	kW	8	8	8	11	11	11	15	15	15	15	15	18	18	30	30	30	30	

\*\* Power input, compressor, at unit operating limits (evaporator water entering/leaving temperature = 15°C/10°C, condenser entering/leaving water temperature = 40°C/45°C) and a nominal voltage of 400 V (data given on the unit name plate).

\*\*\* Maximum unit operating current at maximum unit power input.

\*\*\*\* Maximum instantaneous starting current (maximum operating current of the smallest compressor(s) + locked rotor current or reduced starting current of the largest compressor)

† Current and power inputs not included in the values above

N/A Not available

The 30HXC 080-375 units for high condensing temperatures are directly derived from the standard models. Their application range is the same as that of the standard units, but permits operation at condenser leaving water temperatures up to 63°C. The PRO-DIALOG control offers all the advantages of the standard units, plus control of the condenser leaving water temperature.

### The main modifications are:

- Use of 30GX compressors
- Modification of electrical components to operate with compressors for high condensing temperatures.
- Modification of heat exchangers to meet pressure code requirements (if necessary).

### Option 150

These units are designed for traditional applications for water-cooled units, but for higher condenser leaving water temperatures than 45°C.

Like the standard units they are equipped with condenser entering and leaving water sensors, installed on the piping.

It is possible to control the machine at the condenser water outlet, requiring a factory configuration change and the use of a heating/cooling inlet reversing device.

### Option 150A

These units are designed for water-to-water heat pumps.

They are factory configured as heat pumps (heating/cooling control as a function of the remote reversing device). The condenser incorporates thermal insulation that is identical to that of the evaporator.

### Technical information

All information is identical to that of the standard 30HXC units, except for the following paragraphs.

### Selection

There are no nominal conditions for this unit type. The selection is made using the current electronic catalogue.

### Dimensions

These are identical to those of the standard 30HXC units. The only difference is in the diameter of the incoming field wiring connection, described in the chapter "Recommended selection". Refer to the dimensional drawings for these units, before proceeding with the wiring.

### Compressor

See 30GX compressor table.

### Options and accessories

All options available for the standard 30HXC units are compatible, except:

<b>Option 5, brine unit</b>	Special unit
<b>Option 25, soft start, 30HXC 200-375 units</b>	Not available

### Attention:

*If units have two different operating modes - one with high condensing temperature and the other with low condensing temperature - and the transition is made with the unit in operation, the temperature must not vary by more than 3 K per minute. In cases where this is not possible, it is recommended to go through a unit start/stop switch (remote start/stop available for standard units).*



# Compressors

Reference	Size	I nom.	MHA	LRA	LRA (Y)	LRA (S) 1 cp.	LRA (S) 2 cp.
06NA2146S7N	39	70	95	605	191	220	-
06NA2174S7N	46	90	120	715	226	260	-
06NA2209S7N	56	113	145	856	270	330	420
06NA2250S7N	66	130	175	960	303	380	500
06NA2300S5N	80	156	210	1226	387	445	550
06NA2300S5E	80+	174	240	1265	400	460	600

**Legend:**

- 06NA - Compressor for air-cooled units
- N - Non-economized compressor
- E - Economized compressor
- INOM - Average current draw of the compressor at Eurovent conditions
- MHA - Must hold amperes (maximum operating current) at 360 V
- LRA - Locked rotor current with across-the-line start
- LRA (Y) - Locked rotor current at reduced current (star/delta start-up mode)
- LRA (S) 1 cp. - Start-up with reduced current with electronic starter (start-up duration 3 seconds max.) for one compressor per circuit
- LRA (S) 2 cp. - Start-up with reduced current with electronic starter (start-up duration 3 seconds max.) for two compressors per circuit

## 9 - APPLICATION DATA

### 9.1 - Unit operating range

Evaporator		Minimum	Maximum
Evaporator entering water temperature	°C	6.8*	21
Evaporator leaving water temperature	°C	4**	15
Condenser (water-cooled)		Minimum	Maximum
Condenser entering water temperature	°C	20***	42
Condenser leaving water temperature	°C	25	45
Outside ambient operating temperature 30HXC	°C	6	40
Condenser (air-cooled)		Minimum	Maximum
Outdoor ambient operating temperature	°C	0	46
Available static pressure	kPa		0

**Notes:**

- \* For application requiring operation at less than 6.8°C, contact Carrier s.a. for unit selection using the Carrier electronic catalog.
  - \*\* For application requiring operation at less than 4°C, the units require the use of antifreeze.
  - \*\*\* Water-cooled units (30HXC) operating at full load and below 20°C condenser entering water temperature require the use of a head pressure control with analogue water control valves (see paragraph on head pressure control).
- In temporary operating modes (start-up and at part load) the unit can operate with a condenser entering air temperature of 13°C.

### 9.2 - Minimum chilled water flow

The minimum chilled water flow is shown in the table on the next page. If the flow is less than this, the evaporator flow can be recirculated, as shown in the diagram. The temperature of the mixture leaving the evaporator must never be less than 2.8 K lower than the chilled water entering temperature.

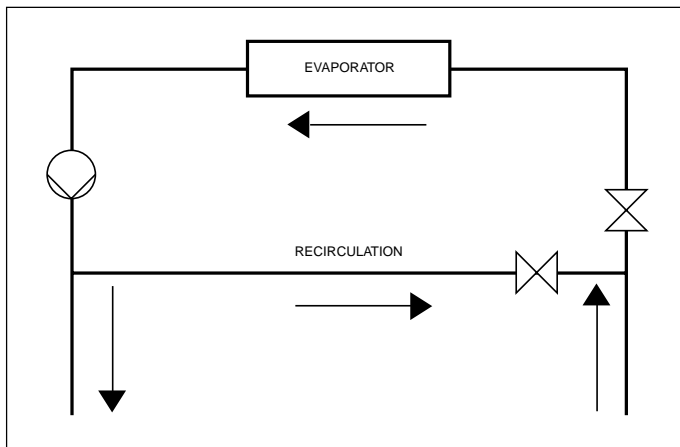

FOR MINIMUM CHILLED WATER FLOW RATE

### 9.3 - Maximum chilled water flow

The maximum chilled water flow is limited by the maximum permitted pressure drop in the evaporator. It is provided in the table on the next page. If the flow exceeds the maximum value, two solutions are possible:

- a - Select a non-standard evaporator with one water pass less which will allow a higher maximum water flow rate.
- b - Bypass the evaporator as shown in the diagram to obtain a higher temperature difference with a lower evaporator flow rate.

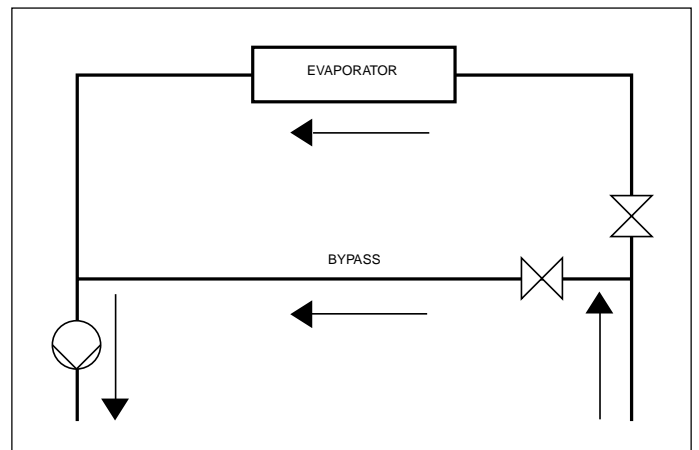

FOR MAXIMUM CHILLED WATER FLOW RATE

## 9.4 - Variable flow evaporator

Variable evaporator flow can be used in standard 30HXC and 30GX chillers. The chillers maintain a constant leaving water temperature under all flow conditions. For this to happen, the minimum flow rate must be higher than the minimum flow given in the table of permissible flow rates and must not vary by more than 10% per minute. If the flow rate changes more rapidly, the system should contain a minimum of 6.5 liters of water per kW instead of 3.25 l/kW.

## 9.5 - System minimum water volume

Whichever the system, the water loop minimum capacity is given by the formula:

$$\text{Capacity} = \text{Cap (kW)} \times \text{N Liters}$$

Application	N
Normal air conditioning	3.25
Process type cooling	6.5

Where Cap is the nominal system cooling capacity (kW) at the nominal operating conditions of the installation.

This volume is necessary for stable operation and accurate temperature control.

It is often necessary to add a buffer water tank to the circuit in order to achieve the required volume. The tank must itself be internally baffled in order to ensure proper mixing of the liquid (water or brine). Refer to the examples below.

**NOTE: The compressor must not restart more than 6 times in an hour.**

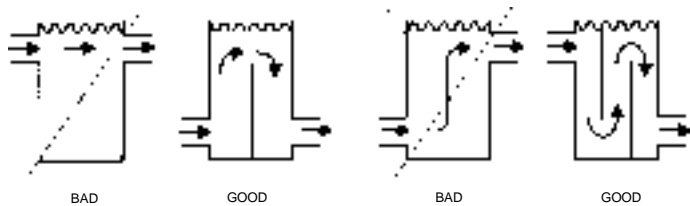

## 9.6 - Cooler flow rate (l/s)

30HXC	Min.*	Max.**
080-090	5.7	22.7
100	6.0	24.1
110	6.9	27.5
120-130	8.3	33.0
140-155	10.0	39.5
175-190	10.7	42.7
200	13.4	53.7
230	13.4	60.6
260-285	17.0	68.1
310	19.4	77.8
345-375	21.3	85.3

30GX	Min.*	Max.**
082	5.7	22.7
092-102	6.0	24.1
112-122	6.9	27.5
132	8.4	33.7
152-162	10.0	39.9
182	10.7	42.7
207-227	13.4	53.7
247	15.1	60.6
267	17.0	68.1
298	19.4	77.8
328-358	21.3	85.3

\* Based on a water velocity of 0.9 m/s.

\*\* Based on a water velocity of 3.6 m/s.

## 9.7 - Condenser flow rate (l/s)

30HXC	Min.*		Max.**
	Closed loop	Open loop	
080-110	2.5	7.5	29.9
120-130	3.1	9.3	37.3
140-155	3.8	11.4	45.5
175-190	4.6	13.8	55.2
200	5.0	14.9	59.6
230-285	6.7	20.1	80.3
310-375	7.3	22.0	88.0

\* Based on a water velocity of 0.3 m/s in a closed loop and 0.9 m/s in an open loop.

\*\* Based on a water velocity of 3.6 m/s.

## 9.8 - Evaporator pressure drop curve

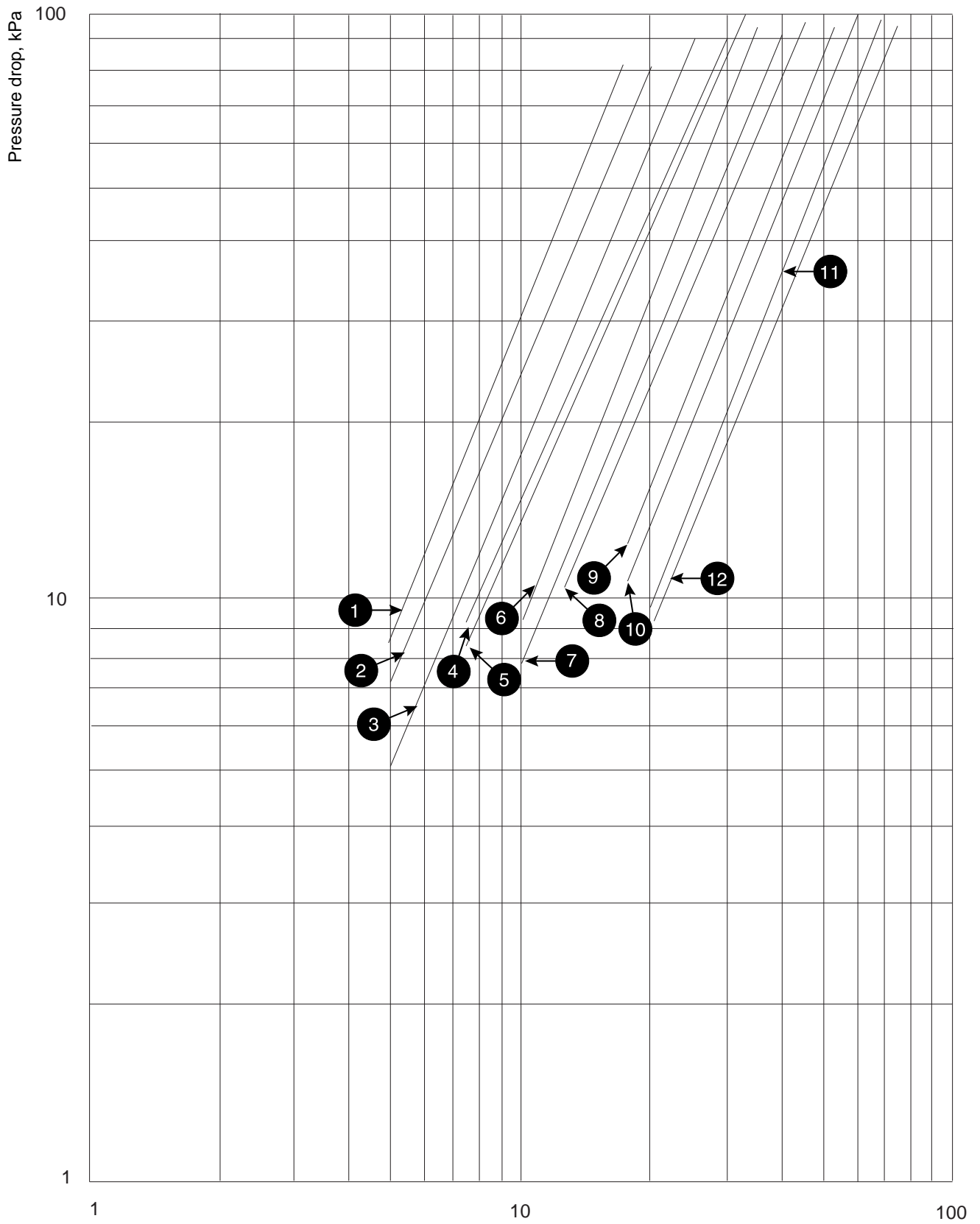

- |                              |                               |
|------------------------------|-------------------------------|
| 1 30HXC 080-090/30GX 082     | 7 30HXC 175-190/30GX 182      |
| 2 30HXC 100/30GX 092-102     | 8 30HXC 200/30GX 207-227      |
| 3 30HXC 110/30GX 112-122     | 9 30HXC 230/30GX 247          |
| 4 30GX 132                   | 10 30HXC 260-285/30GX 267     |
| 5 30HXC 120-130              | 11 30HXC 310/30GX 298         |
| 6 30HXC 140-155/30GX 152-162 | 12 30HXC 345-375/30GX 328-358 |

Water flow rate, l/s

## 9.9 - Condenser pressure drop curve

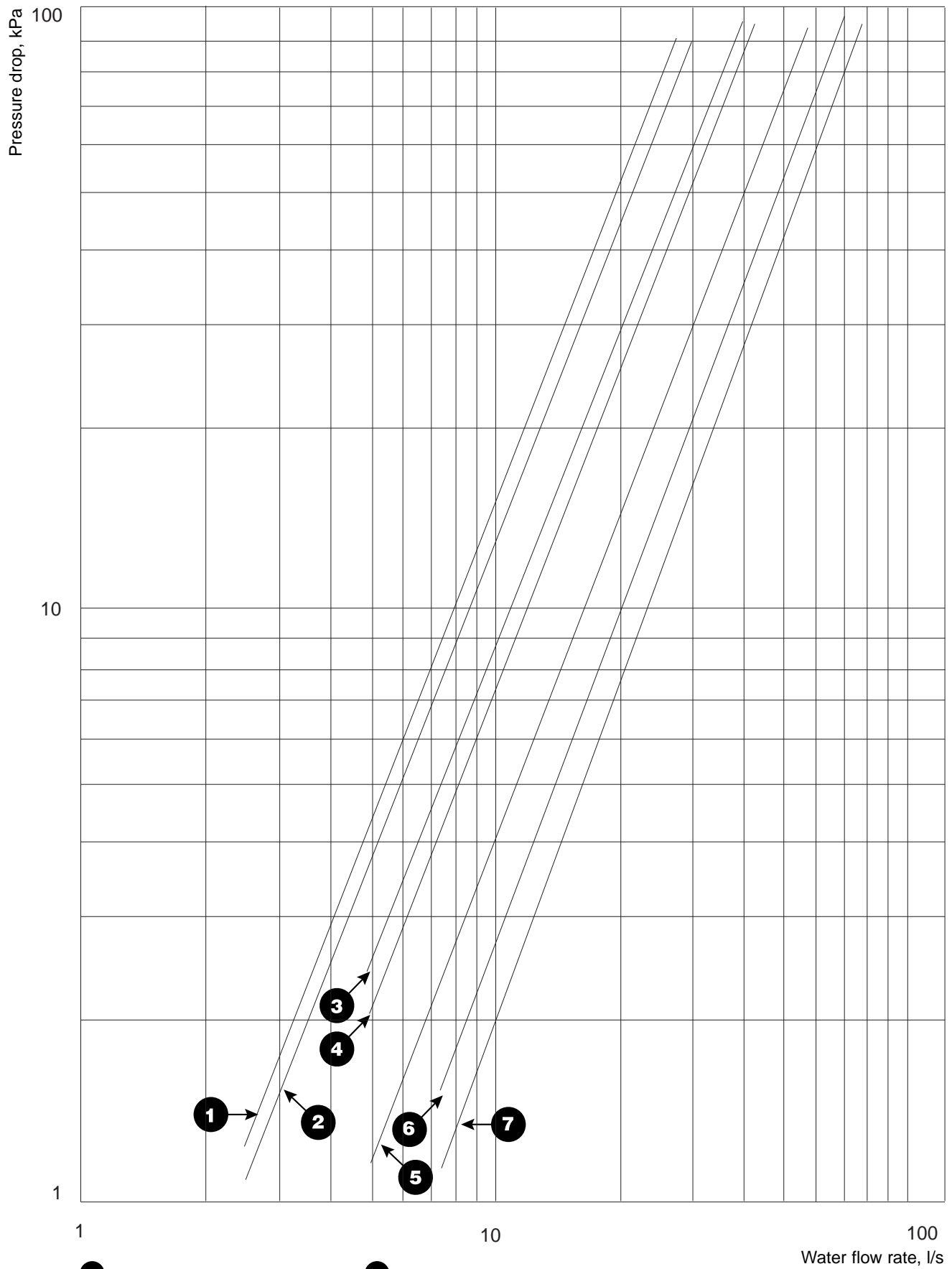

- |                                |                            |
|--------------------------------|----------------------------|
| <b>1</b> 30HXC 080-090-100-110 | <b>5</b> 30HXC 200         |
| <b>2</b> 30HXC 120-130         | <b>6</b> 30HXC 230-260-285 |
| <b>3</b> 30HXC 140-155         | <b>7</b> 30HXC 310-345-375 |
| <b>4</b> 30HXC 175-190         |                            |



## 9.10 - Flow controllers

### 9.10.1 - Cooler flow switch and chilled water pump interlock

#### **IMPORTANT**

***It is mandatory to install cooler flow switch and also to connect chilled water pump interlock on 30HXC and 30GX. Failure to this instruction will void Carrier guarantee.***

The cooler flow switch controller is factory supplied and wired on 30HXC and 30GX units.

Follow the manufacturer instruction for installation.

The flow switch may be mounted in a horizontal pipe or a vertical pipe with upward liquid flow. It should not be used when liquid flow is downwards.

Mount in a section of pipe where there is a straight run of at least five pipe diameters on each side of the flow switch. Do not locate adjacent to valves, elbows or orifices. The paddle must never touch the pipe or any restriction in the pipe. Screw the flow switch in position so the flat part of the paddle is at right angles to the flow. The arrows on the cover and in the bottom, inside the case, must point in the direction of the flow. The switch should be mounted so that the terminals are accessible for easy wiring.

Terminals 34 and 35 are provided for field installation of a chilled water pump interlock (auxiliary contact of chilled water pump contactor).

(Pipe connection: 1" NPT)

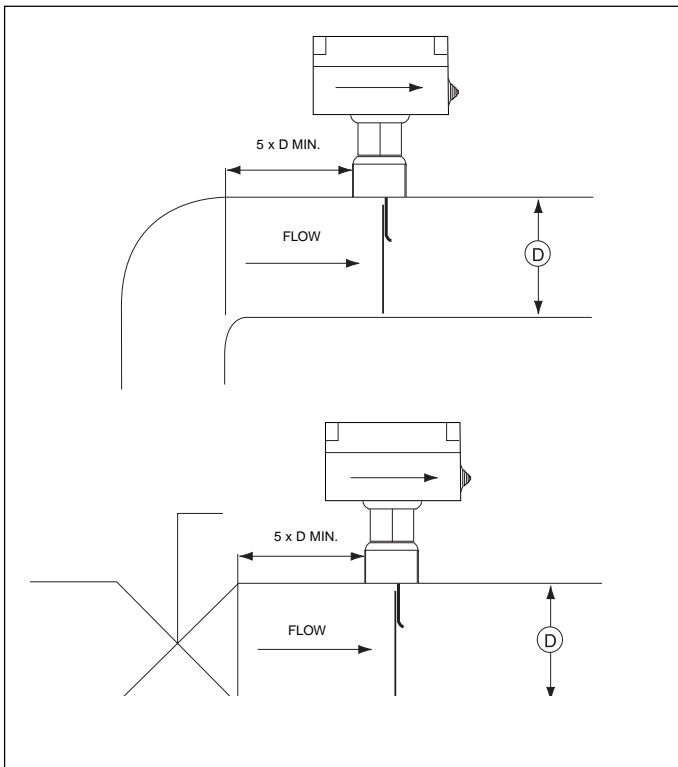

### 9.10.2 - Condenser flow switch (30HXC)

The condenser flow switch is a field-installed device.

## 10 - INSTALLATION

### 10.1 - Check equipment received

- Inspect the unit for damage or missing parts. If damage is detected, or if shipment is incomplete, immediately file a claim with the shipping company.
- Confirm that the unit received is the one ordered. Compare the nameplate data with the order.
- Confirm that all accessories ordered for on-site installation have been delivered, and are complete and undamaged.
- Do not store units in an area exposed to weather because of sensitive control mechanism and electronic devices.

### 10.2 - Moving and siting the unit

#### 10.2.1 - Moving

Do not remove skids, pallets or protective packaging until the unit is in its final position. Move the chiller using tubes or rollers, or lift it, using slings of the correct capacity.

#### **CAUTION (30HXC)**

***Only use slings at the designated lifting points which are marked on the unit, on the top of the cooler heat exchanger. Rigging from the bottom of the heat exchanger will cause the unit to be lifted unsafely. Personal injury or damage to the unit may occur. Follow the rigging instruction given on the certified dimensional drawing supplied with the unit.***

#### 10.2.2 - Siting

Always refer to the chapter "Dimensions and clearances" to confirm that there is adequate space for all connections and service operation. For the center of gravity coordinates, the position of the unit mounting holes, and the weight distribution points, refer to the certified dimensional drawing supplied with the unit.

We recommend that these chillers be installed either in a basement or at ground level. If one is to be installed above ground level, first check that the permissible floor loading is adequate and that the floor is strong enough and level. If necessary, strengthen and level the floor.

With the chiller in its final location remove the skids, and other devices used to aid in moving it. Level the unit using a spirit level, and bolt the unit to the floor or plinth. Operation of these units may be impaired if they are not level and not securely fixed to their mountings. If required use isolation pads under the unit to aid in vibration isolation.

# 11 - LIFTING INSTRUCTIONS

## 11.1 - 30HXC 080-190

This diagram is shown for information only. Refer to “certified drawings”.

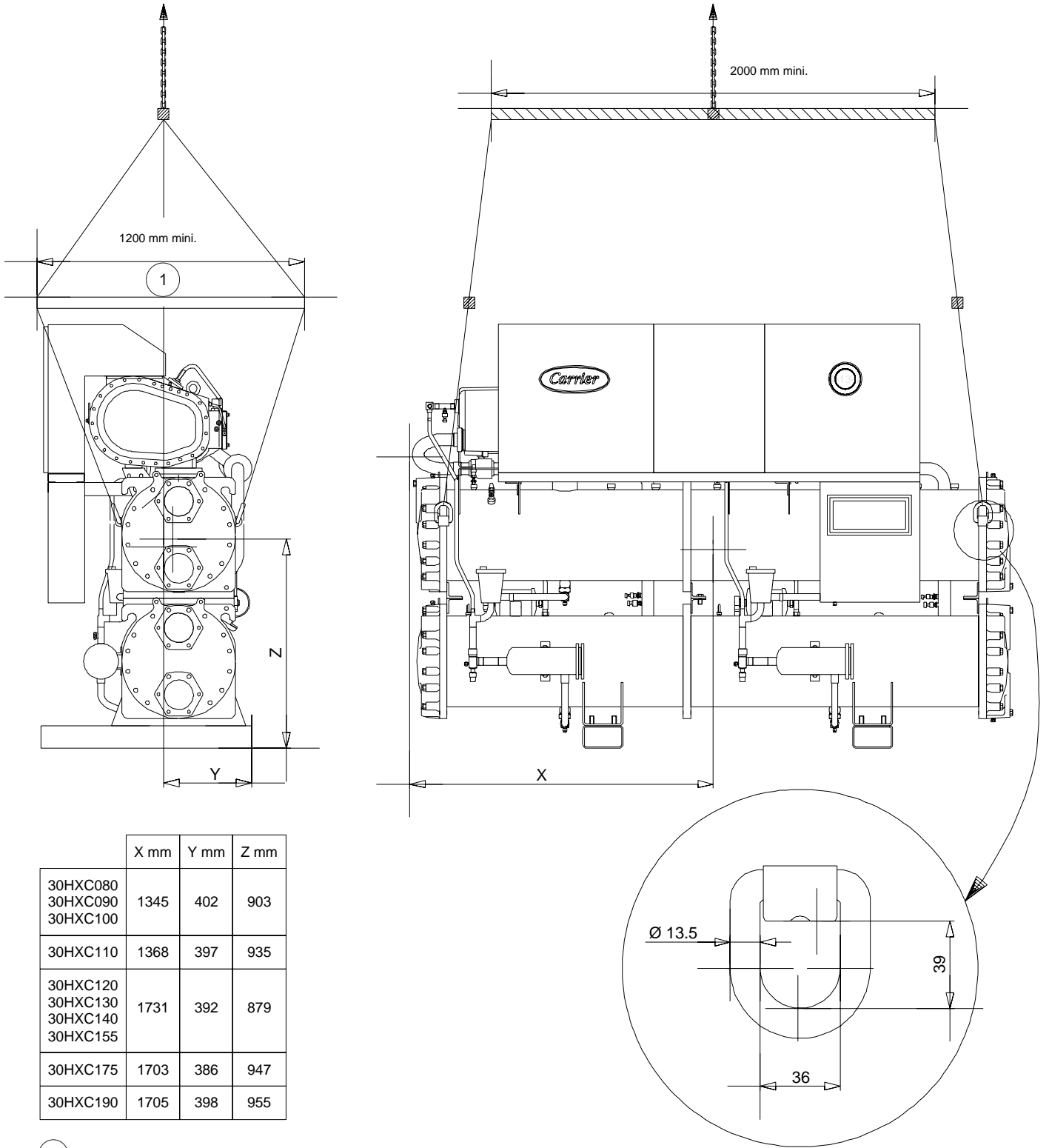

	X mm	Y mm	Z mm
30HXC080 30HXC090 30HXC100	1345	402	903
30HXC110	1368	397	935
30HXC120 30HXC130 30HXC140 30HXC155	1731	392	879
30HXC175	1703	386	947
30HXC190	1705	398	955

1 EXCEPT 30HXC 190

### NOTE

When all lifting and positioning operations are finished, it is recommended to touch up all surfaces where paint has been removed on lifting lugs.

# 11 - LIFTING INSTRUCTIONS (CONT.)

## 11.2 - 30HXC 200-285

This diagram is shown for information only. Refer to “certified drawings”.

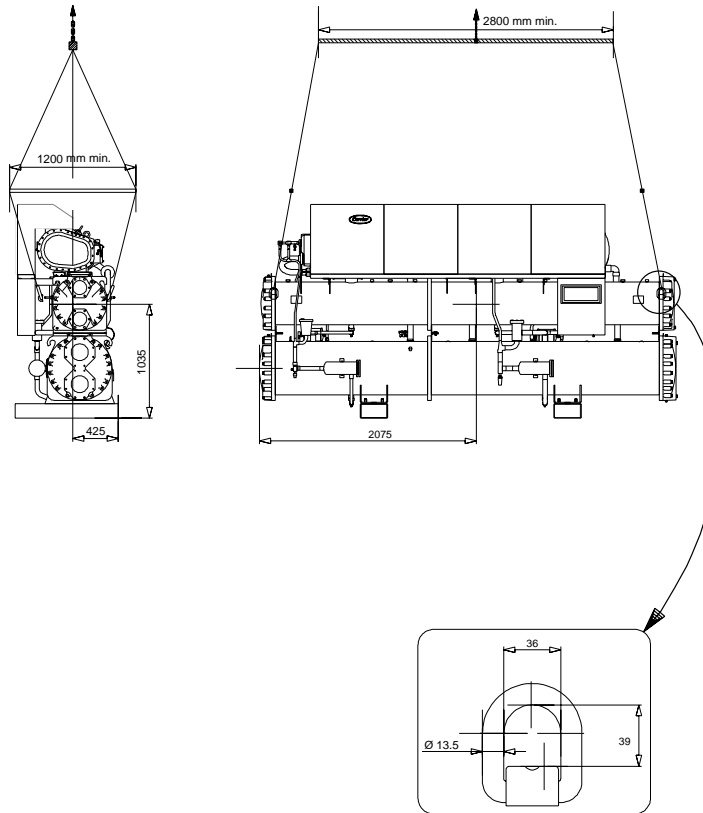

## 11.3 - 30HXC 310-375

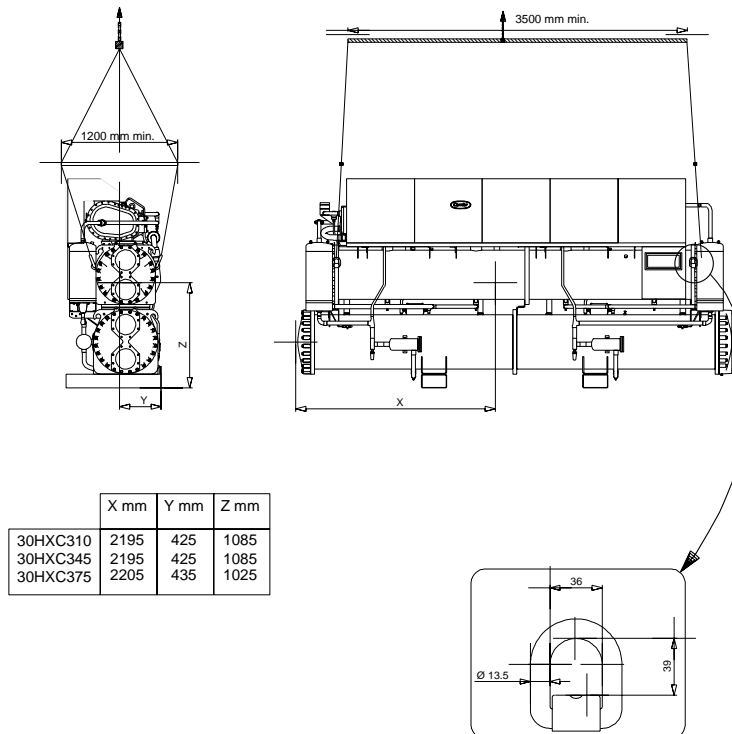

**NOTE**

When all lifting and positioning operations are finished, it is recommended to touch up all surfaces where paint has been removed on lifting lugs.

## 11 - LIFTING INSTRUCTIONS (CONT.)

### 11.4 - 30GX 082-162

This diagram is shown for information only. Refer to “certified drawings”.

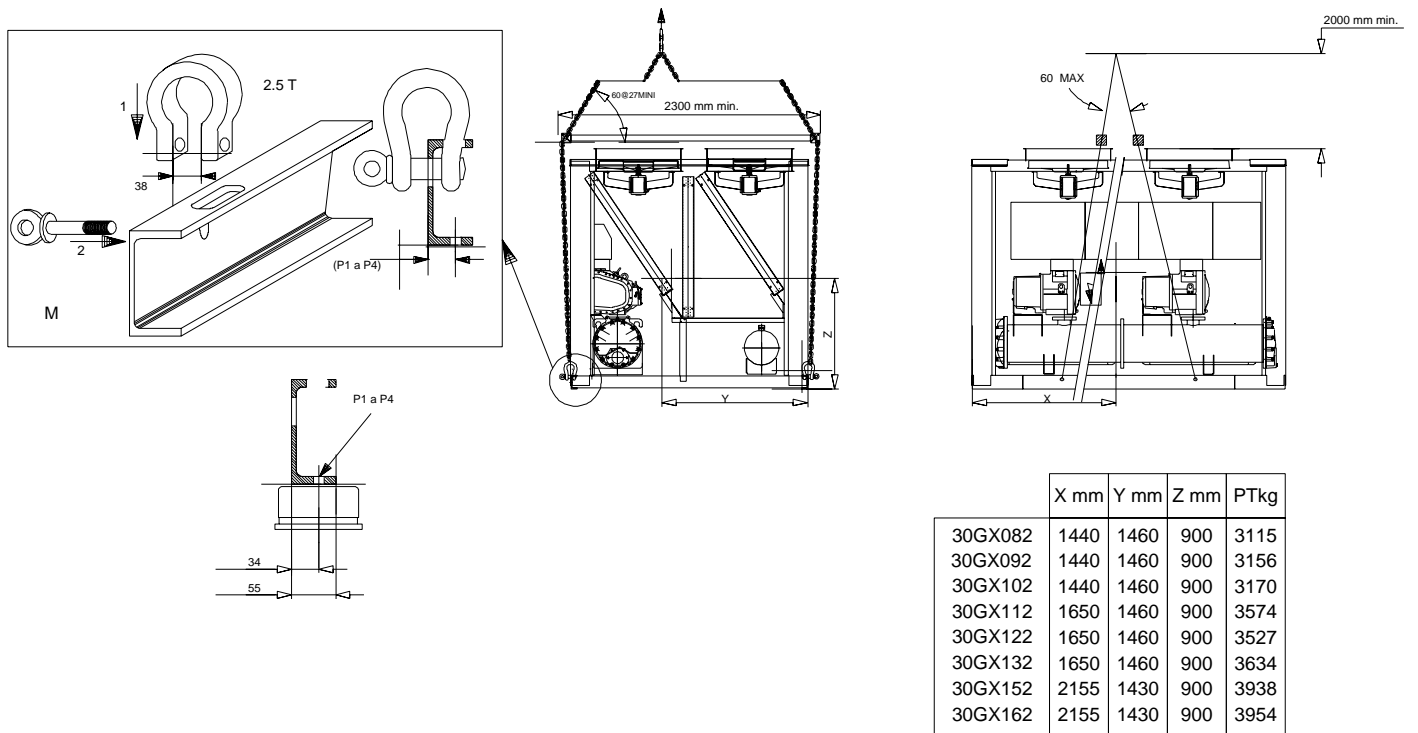

### 11.5 - 30GX 182

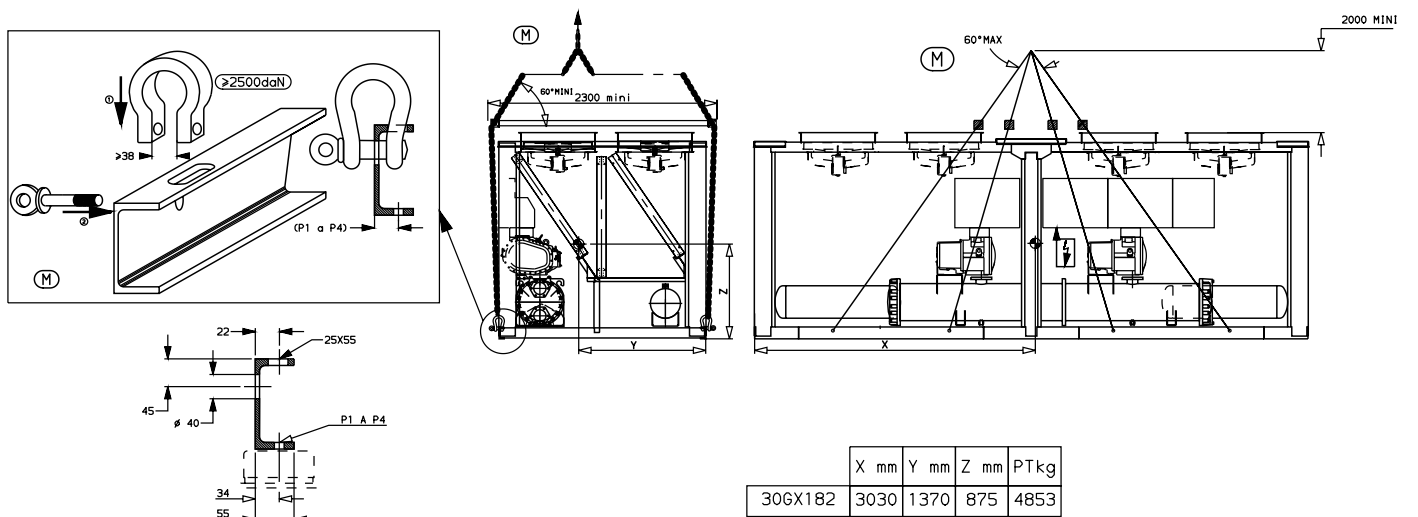

#### NOTE

When all lifting and positioning operations are finished, it is recommended to touch up all surfaces where paint has been removed on lifting lug

# 11 - LIFTING INSTRUCTIONS (CONT.)

## 11.6 - 30GX 207-267

This diagram is shown for information only. Refer to “certified drawings”..

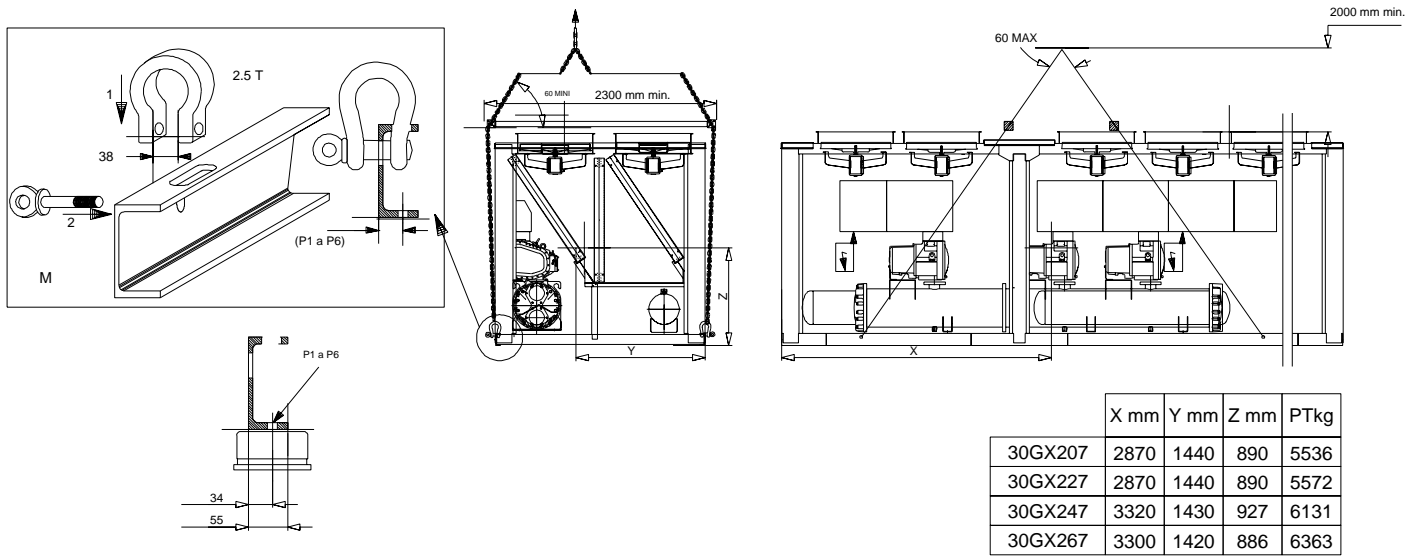

## 11.7 - 30GX 298-358

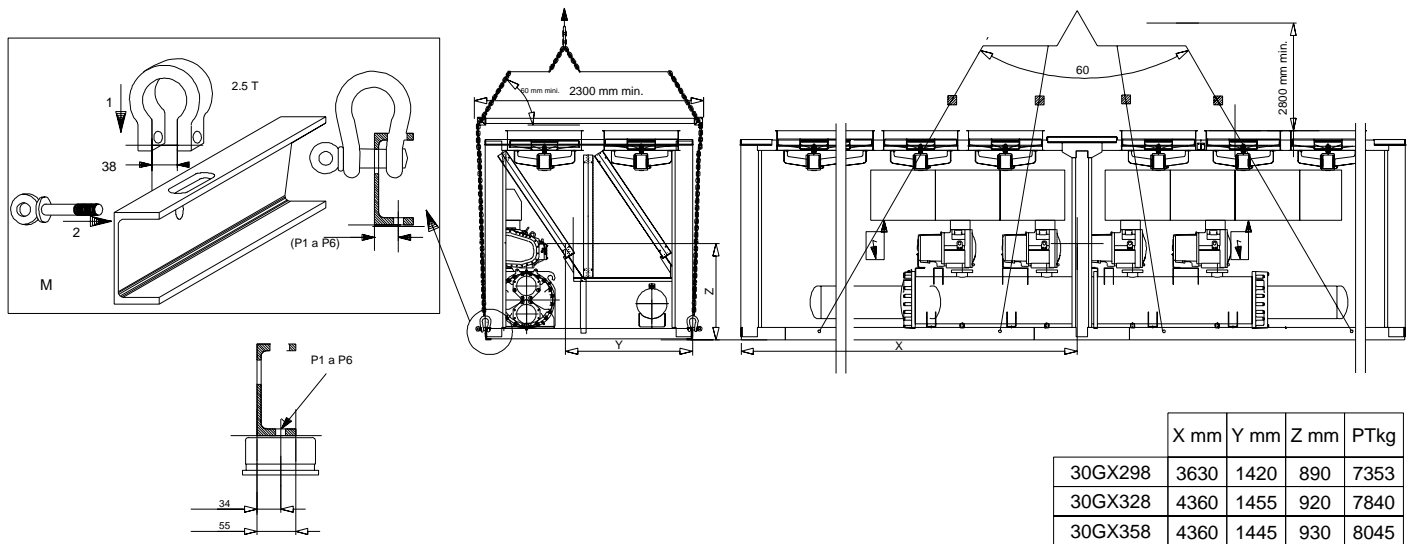

**NOTE**

When all lifting and positioning operations are finished, it is recommended to touch up all surfaces where paint has been removed on lifting lugs.

## 11.8 - Piping connections

Refer to the certified dimensional drawings for the sizes and positions of all water inlet and outlet connections. The water pipes must not transmit any radial or axial force to the heat exchangers or any vibration to the pipework or building.

The water supply must be analysed and appropriate filtering, treatment, control devices, isolation and bleed valves and circuits built in, as necessary. Consult either a water treatment specialist or appropriate literature on the subject.

### 11.8.1 - Operating precautions

The water circuit should be designed to have the least number of elbows and horizontal pipe runs at different levels. The following basic checks should be done (see also the illustration of a typical hydraulic circuit below).

- Note the water inlets and outlets of the heat exchangers.
- Install manual or automatic air purge valves at all high points in the water circuit.
- Use an expansion chamber or an expansion/relief valve to maintain pressure in the system.
- Install water thermometers and pressure gauges in both the entering and leaving water connections close to the evaporator.
- Install drain valves at all low points to allow the whole circuit to be drained. Connect a stop valve in the drain line before operating the chiller.
- Install stop valves and pressure gauges, close to the evaporator, in the entering and leaving water lines.
- Install cooler flow switch.
- Use flexible connections to reduce the transmission of vibration to the pipework.
- Insulate all pipework, after testing for leaks, both to reduce thermal leaks and to prevent condensation.
- Cover the insulation with a vapour barrier.

### 11.8.2 - Evaporator and condenser connections

The evaporator and condenser are of the multi-tube shell and tube type with removable water boxes to facilitate cleaning of the tubes.

Before making water connections tighten the bolts in both heads to the lower torque shown, following the method described. Tighten in the pairs and sequence indicated according to the size of bolt (see table) using a torque value at the low end of the range given.

#### CAUTION

**Remove the factory supplied flat flange from the water box before welding piping to the flange. Failure to remove the flange may damage the sensors and insulation.**

#### NOTE

**We recommend draining the system and disconnecting the pipework to ensure that the bolts of the heads to which the pipework is connected are correctly and uniformly tightened.**

## 11.8.3 - Freeze protection

### Evaporator and water-cooled condenser protection

If the chiller or the water piping is in an area where the ambient temperature can fall below 0°C it is recommended to add an antifreeze solution to protect the unit and the water piping to a temperature of 8 K below the lowest temperature. Use only antifreeze solutions, approved for heat exchanger duty. If the system is not protected by an antifreeze solution and will not be used during the freezing weather conditions, draining of the cooler and outdoor piping is mandatory. Damage due to freezing is not covered by the warranty.

### Water box tightening sequence

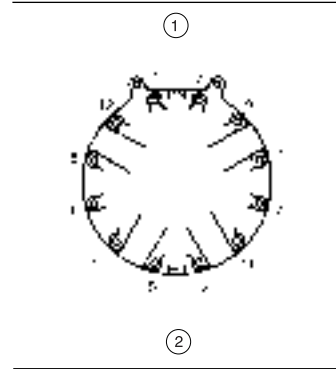

#### Legend

- 1 Sequence 1: 1 2 3 4  
 Sequence 2: 5 6 7 8  
 Sequence 3: 9 10 11 12
- 2 Tightening torque  
 Bolt size M16 - 171 - 210 Nm

### Typical hydraulic circuit diagram

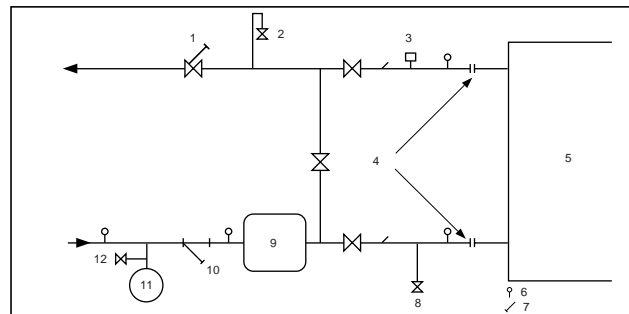

#### Legend

- 1 Control valve  
 2 Air vent  
 3 Flow switch  
 4 Flexible connection  
 5 Heat exchanger  
 6 Pressure tap  
 7 Thermostat sleeve  
 8 Drain  
 9 Buffer tank  
 10 Filter  
 11 Expansion tank  
 12 Fill valve

## 12 - ELECTRICAL CHARACTERISTICS

- The 30HXC 080-190 and 30GX 082-182 have only one power disconnect/isolating switch.
- **The 30HXC 200-375 and 30GX 207-358 have two power disconnect/isolating switches.**
- The control box incorporates the following as standard:
  - Starters and motor protection devices for each compressor and the fans
  - Control components
- **Connections on site:**  
*All mains connections and electrical installation must be carried out in accordance with the directives applicable to the site.*
- The 30HXC and 30GX are designed to facilitate compliance with these directives. The engineering of the electrical equipment for the 30HXC and 30GX takes account of European standard EN 60204-1 (safety of machinery - electrical equipment of machines - Part 1: general rules).

### IMPORTANT

*Standard EN 60204-1 is a good means of responding to the requirements of the Machinery Directive § 1.5.1. The normative recommendation IEC 364, is generally recognized as meeting the requirements of the installation regulation.*

*Annex B of standard EN 60204-1 may be used to describe the electrical characteristics under which the machines operate.*

### 12.1 - 30HXC

1. The operating conditions for a standard 30HXC are described below:
    - Environmental conditions<sup>(1)</sup>. The environmental classification is described in standard IEC 364 § 3:
      - Ambient temperature range: + 6°C to + 40°C, classification AA4
      - Humidity range (non condensing)
        - 50 % rh at 40°C
        - 90 % rh at 20°C
      - Altitude - 2000 m<sup>(1)</sup>
      - For indoor installation
      - Presence of water: classification AD2<sup>(1)</sup> (possibility of water droplets)
      - Presence of solids: classification AE2<sup>(1)</sup> (presence of insignificant particulates)
      - Presence of corrosives and contaminants, classification AF1 (negligible)
      - Vibration, shock: classification AG2, AH2
- Competence of personnel: classification BA4<sup>(1)</sup> (personnel qualified in accordance with IEC 364).
- <sup>(1)</sup> The protection standard required in respect of this classification is IP21B (in accordance with the reference document IEC 529). All 30HXC have a protection standard of IP23C and therefore fulfil this protection requirement.

### 12.2 - 30GX

2. The operating conditions for 30GX are described below:
  - Environmental conditions<sup>(2)</sup>. The environmental classification is described in standard EN 60721:
    - For outdoor installation<sup>(2)</sup>

- Ambient temperature range: - 18°C to + 46°C, classification 4K3<sup>(2)</sup>
  - Altitude ≤ 2000 m<sup>(2)</sup>
  - Presence of solids: classification 4S2 (presence of insignificant particulates)
  - Presence of corrosives and contaminants, classification 4C2 (negligible)
  - Vibration, shock: classification 4M2
- Competence of personnel: classification BA4(2) (personnel qualified in accordance with IEC 364).

- <sup>(2)</sup> The protection standard required in respect of this classification is IP43BW (in accordance with the reference document IEC 529). All 30GX have a protection standard of IP45CW and therefore fulfil this protection requirement.

### 12.3 - 30HXC/GX

3. Fluctuation in power supply frequency: ± 2 Hz
4. Overcurrent protection for the power supply conductors is not supplied with the device.
5. The factory-fitted disconnect/isolating switch is a type “a” isolator. (EN60204-1 § 5.3.2).

**NOTE:** *If particular aspects of an installation require characteristics other than those listed above (or characteristics not referred to here) contact your Carrier representative.*

#### 12.3.1 - Power supply

The power supply must conform to the specification on the chiller nameplate. The supply voltage must be within the range specified in the electrical data table.  
 For connections refer to the wiring diagrams.

**WARNING:** *Operation of the chiller with an improper supply voltage or excessive phase imbalance constitutes abuse which will invalidate the Carrier warranty. If the phase imbalance exceeds 2% for voltage, or 10% for current, contact your local electricity supply at once and ensure that the chiller is not switched on until corrective measures have been taken.*

#### 12.3.2 - Voltage phase imbalance (%):

$$\frac{100 \times \text{max. deviation from average voltage}}{\text{Average voltage}}$$

#### Example:

On a 400 V - 3 ph - 50 Hz supply, the individual phase voltages were measured to be:

$$\begin{aligned} AB &= 406 \text{ V} ; BC = 399 ; AC = 394 \text{ V} \\ \text{Average voltage} &= (406 + 399 + 394)/3 = 1199/3 \\ &= 399.7 \text{ say } 400 \text{ V} \end{aligned}$$

Calculate the maximum deviation from the 400 V average:

$$\begin{aligned} (AB) &= 406 - 400 = 6 \\ (BC) &= 400 - 399 = 1 \\ (CA) &= 400 - 394 = 6 \end{aligned}$$

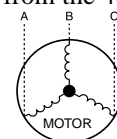

The maximum deviation from the average is 6 V. The greatest percentage deviation is:

$$100 \times 6/400 = 1.5 \%$$

This is less than the permissible 2% and is therefore acceptable.

### 13 - RECOMMENDED WIRE SECTIONS

Wire sizing is the responsibility of the installer, and depends on the characteristics and regulations applicable to each installation site. The following is only to be used as a guideline, and does not make Carrier in any way liable. After wire sizing has been completed, using the certified dimensional drawing, the installer must ensure easy connection and define any modifications necessary on site.

The connections provided as standard for the field-supplied power entry cables to the general disconnect/isolator switch are designed for the number and type of wires, listed in the table below.

The calculations are based on the maximum machine current (see electrical data tables).

For the design the following standardised installation methods are used, in accordance with IEC 364, table 52C:

- For 30HX units installed inside the building: No.13: perforated horizontal cable conduit, and No. 41: closed conduit.
- For 30GX units installed outside the building: No.17: suspended aerial lines, and No. 61: buried conduit with a derating coefficient of 20.

The calculation is based on PVC or XLPE insulated cables with copper or aluminium core. The maximum temperature is 40°C for 30HX units and 46°C for 30GX units.

The given wire length limits the voltage drop to < 5%.

Unit	Min. (mm <sup>2</sup> ) by phase	Wire type	L (m)	Max. (mm <sup>2</sup> ) by phase	Wire type	L (m)
30HX 080	1 x 35	XLPE Cu	140	1 x 120	PVC AI	260
30HX 090	1 x 50	XLPE Cu	160	1 x 120	PVC AI	260
30HX 100	1 x 50	XLPE Cu	160	1 x 95	XLPE AI	195
30HX 110	1 x 70	XLPE Cu	170	1 x 120	XLPE AI	205
30HX 120/130	1 x 70	XLPE Cu	170	1 x 150	XLPE AI	210
30HX 140	1 x 95	XLPE Cu	180	1 x 185	XLPE AI	220
30HX 155	1 x 95	XLPE Cu	180	1 x 240	XLPE AI	225
30HX 175	1 x 120	XLPE Cu	185	1 x 240	XLPE AI	225
30HX 190	1 x150	XLPE Cu	190	2 x 95	XLPE AI	195
30HX 200 ckt A	1 x 70	XLPE Cu	170	2 x120	PVC AI	325
30HX 230 ckt A	1 x 95	XLPE Cu	180	2 x 120	PVC AI	325
30HX 260 ckt A	1 x 120	XLPE Cu	185	1 x 240	XLPE AI	225
30HX 285 ckt A	1 x 150	XLPE Cu	190	2 x 150	XLPE AI	265
30HX 200 ckt B	1 x 35	XLPE Cu	140	1 x 95	PVC AI	250
30HX 230 ckt B	1 x 35	XLPE Cu	140	1 x 120	PVC AI	260
30HX 260 ckt B	1 x 35	XLPE Cu	140	1 x 120	PVC AI	260
30HX 285 ckt B	1 x 50	XLPE Cu	160	2 x 70	PVC AI	285
30HX 310 ckt A & B	1 x 95	XLPE Cu	180	1 x 240	XLPE AI	225
30HX 345 ckt A & B	1 x 120	XLPE Cu	185	1 x 240	XLPE AI	225
30HX 375 ckt A & B	1 x 150	XLPE Cu	190	2 x 150	XLPE AI	265
30GX 082	1 x 95	XLPE Cu	190	2 x 185	PVC AI	420
30GX 092	1 x 120	XLPE Cu	195	2 x 185	PVC AI	420
30GX 102	1 x 120	XLPE Cu	195	2 x 240	PVC AI	450
30GX 112	1 x 150	XLPE Cu	200	2 x 150	XLPE AI	300
30GX 122	1 x 185	XLPE Cu	205	2 x 185	XLPE AI	315
30GX 132	1 x 185	XLPE Cu	205	2 x 240	XLPE AI	330
30GX 152	1 x 240	XLPE Cu	205	3x 185	XLPE CU	430
30GX 162	2 x 95	XLPE Cu	190	3x 240	XLPE CU	440
30GX 182	2 x 120	XLPE Cu	200	3x 240	XLPE CU	440
30GX 207 ckt A	1 x 185	XLPE Cu	205	3x 185	XLPE AI	445
30GX 227 ckt A	1 x 240	XLPE Cu	205	3x 240	XLPE AI	470
30GX 247/298/328 ckt A	2 x 120	XLPE Cu	225	3x 185	XLPE CU	490
30HX 267/358 ckt A	2 x 150	XLPE Cu	230	3x 240	XLPE CU	505
30GX 207/227/247 ckt B	1 x 95	XLPE Cu	190	2 x 240	PVC AI	560
30HX 267 ckt B	1 x 120	XLPE Cu	200	2 x 185	XLPE AL	395
30GX 298 ckt B	1 x 185	XLPE Cu	205	3x 240	XLPE AL	470
30GX 328 ckt B	2 x 120	XLPE Cu	225	3x 185	XLPE CU	490
30GX 358 ckt B	2 x 150	XLPE Cu	230	3x 240	XLPE CU	505



**IMPORTANT**

*Before connection of the main power cables (L1 - L2 - L3) on the terminal block, it is imperative to check the correct order of the 3 phases before proceeding to the connection on then terminal block or the main disconnect/isolator switch.*

**13.1 - Field control wiring**

Refer to the Controls IOM and the certified wiring diagram supplied with the unit for the field control wiring of the following features:

- Evaporator pump interlock (mandatory)
- Remote on/off switch
- Condenser flow switch (field-supplied, 30HXC only)
- Remote heat/cool switch
- Demand limit external switch 1
- Remote dual set point
- Alarm report by circuit
- Evaporator pump control
- Condenser pump control (30HXC only)
- Remote set point reset or outside air temperature sensor reset (0-10 V)

**Recommended wire sections for units with high condensing temperatures (400 V - 3 ph - 50 Hz)**

Unit, options 150 + 150A 400 V - 3 ph - 50 Hz	Min. (mm <sup>2</sup> ) by phase	Wire type	L (m)	Max. (mm <sup>2</sup> ) by phase	Wire type	L (m)
30HXC 080 OPT. 150	1 x 50	XLPE Cu	150	2 x 70	PVC AI	230
30HXC 090 OPT. 150	1 x 70	XLPE Cu	160	2 x 95	PVC AI	260
30HXC 100 OPT. 150	1 x 70	XLPE Cu	160	2 x 95	PVC AI	250
30HXC 110 OPT. 150	1 x 95	XLPE Cu	170	2 x 120	PVC AI	265
30HXC 120 OPT. 150	1 x 120	XLPE Cu	180	2 x 120	XLPE AI	205
30HXC 130 OPT. 150	1 x 120	XLPE Cu	160	2 x 120	XLPE AI	210
30HXC 140 OPT. 150	1 x 150	XLPE Cu	175	2 x 120	XLPE AI	205
30HXC 155 OPT. 150	1 x 185	XLPE Cu	185	2 x 150	XLPE AI	215
30HXC 175 OPT. 150	1 x 240	XLPE Cu	185	2 x 150	XLPE AI	210
30HXC 190 OPT. 150	2 x 95	XLPE Cu	175	2 x 240	XLPE AI	220
30HXC 200 OPT. 150 circ. A	1 x 120	XLPE Cu	170	2 x 150	XLPE AI	270
30HXC 230 OPT. 150 circ. A	1 x 150	XLPE Cu	180	2 x 185	XLPE AI	270
30HXC 260 OPT. 150 circ. A	1 x 185	XLPE Cu	180	2 x 240	XLPE AI	295
30HXC 285 OPT. 150 circ. A	1 x 240	XLPE Cu	170	2 x 185	XLPE Cu	265
30HXC 310 OPT. 150 circ. A	1 x 185	XLPE Cu	180	2 x 240	XLPE AI	300
30HXC 345 OPT. 150 circ. A	1 x 185	XLPE Cu	170	2 x 240	XLPE AI	280
30HXC 375 OPT. 150 circ. A	1 x 240	XLPE Cu	170	2 x 185	XLPE Cu	265
30HXC 200 OPT. 150 circ. B	1 x 35	XLPE Cu	125	2 x 95	PVC AI	320
30HXC 230 OPT. 150 circ. B	1 x 50	XLPE Cu	140	2 x 95	PVC AI	310
30HXC 260 OPT. 150 circ. B	1 x 50	XLPE Cu	140	2 x 95	PVC AI	310
30HXC 285 OPT. 150 circ. B	1 x 70	XLPE Cu	160	2 x 120	PVC AI	325
30HXC 310 OPT. 150 circ. B	1 x 150	XLPE Cu	180	2 x 185	XLPE AI	275
30HXC 345 OPT. 150 circ. B	1 x 185	XLPE Cu	185	2 x 240	XLPE AI	305
30HXC 375 OPT. 150 circ. B	1 x 185	XLPE Cu	160	2 x 240	XLPE AI	280

## 14 - MAJOR SYSTEM COMPONENTS AND OPERATION DATA

### 14.1 - Geared twin screw compressor

- 30HXC and 30GX units use 06N geared twin screw compressors
- 06NA are used on 30GX (air-cooled condensing application)
- 06NW are used on 30HXC (water-cooled condensing application)
- Nominal capacities range from 39 to 80 tons. Economized or non economized models are used depending on the 30HXC and 30GX unit size.

#### 14.1.1 - Oil Filter

The 06N screw compressor has an oil filter integral in the compressor housing. This filter is field replaceable.

#### 14.1.2. - Refrigerant

The 06N screw compressor is specially designed to be used in R134 a system only.

#### 14.1.3 - Lubricant

The 06N screw compressor is approved for use with the following lubricant.

CARRIER MATERIAL SPEC PP 47-32

#### 14.1.4 - Oil Supply Solenoid Valve

An oil supply solenoid valve is standard on the compressor to isolate the compressor from oil flow when the compressor is not operating.

The oil solenoid is field replaceable.

#### 14.1.5 - Suction & Economizer Screens

To increase the reliability of the compressor, a screen has been incorporated as a standard feature into suction and economizer inlets of the compressor.

#### 14.1.6 - Unloading System

The 06N screw compressor has an unloading system that is standard on all compressors. This unloading system consists of two steps of unloading that decrease the compressor capacity by rerouting partially compressed gas back to suction.

### 14.2 - Evaporator

30HXC and 30GX chillers use a flooded evaporator. The water circulates in the tubes and the refrigerant is on the outside in the shell. One vessel is used to serve both refrigerant circuits. There is a center tube sheet which separates the two refrigerant circuits. The tubes are 3/4" diameter copper with an enhanced surface inside and out. There is just one water circuit, and depending on the size of the chiller, there may be two or three water passes. A cooler liquid level sensor provides optimized flow control.

At the top of the cooler are the two suction pipes, one in each circuit. Each has a flange welded to it, and the compressor mounts on the flange.

### 14.3 - Condenser and oil separator (30HXC)

30HXC chiller use a vessel that is a combination condenser and oil separator. It is mounted below the cooler. Discharge gas leaves the compressor and flows through an external muffler to the oil separator, which is the upper portion of the vessel. It

enters the top of the separator where oil is removed, and then flows to the bottom portion of the vessel, where gas is condensed and subcooled. One vessel is used to serve both refrigerant circuits. There is a center tube sheet which separates the two refrigerant circuits. The tubes are 3/4" or 1" diameter copper with enhanced surface inside and out. There is just one water circuit with two water passes.

### 14.4 - Oil separator (30GX)

In the air-cooled units, the oil separator is a pressure vessel that is mounted under the outside vertical condenser coils.

Discharge gas enters at the top of the separator where much of the oil separates and drains to the bottom. The gas then flows through a wire mesh screen where the remaining oil is separated and drains to the bottom.

### 14.5 - Electronic Expansion Device (EXD)

The microprocessor controls the EXD through the EXV control module. The EXD will either be an EXV or an Economizer. Inside both these devices is a linear actuator stepper motor. High-pressure liquid refrigerant enters the valve through the bottom. A series of calibrated slots are located inside the orifice assembly. As refrigerant passes through the orifice, the pressure drops and the refrigerant changes to a 2-phase condition (liquid and vapor). To control refrigerant flow for different operating conditions, the sleeve moves up and down over the orifice, thereby changing effective flow area of expansion device. The sleeve is moved by a linear stepper motor. The stepper motor moves in increments and is controlled directly by the processor module. As the stepper motor rotates, motion is transferred into linear movement by the lead screw. Through the stepper motor and lead screws, 1500 discrete steps of motion are obtained. The large number of steps and long stroke result in very accurate control of refrigerant flow. Each circuit has a liquid level sensor mounted vertically into the top of the cooler shell. The level sensor consists of a small electric resistance heater and three thermistors wired in series positioned at different heights inside the body of the well. The heater is designed so that the thermistors will read approximately 93.3°C in dry air. As the refrigerant level rises in the cooler, the resistance of the closest thermistor(s) will greatly change. This large resistance difference allows the control to accurately maintain a specified level. The level sensor monitors the refrigerant liquid level in the cooler and sends this information to the PSIO-1. At initial start-up, the EXV position is at zero. After that, the microprocessor keeps accurate track of the valve position in order to use this information as input for the other control functions. It does this by initializing the EXV's at startup. The processor sends out enough closing pulses to the valve to move it from fully open to fully closed, then resets the position counter to zero. From this point on, until the initialization, the processor counts the total number of open and closed steps it has sent to each valve.

### 14.6 - Economizer

Economizers are installed on 30HXC 190, 285 and 375 and 30GX 182, 267 and 358.

The economizer improves both the chiller capacity and efficiency as well as providing compressor motor cooling. Inside the economizer are both a linear EXV stepper motor and a float valve. The EXV is controlled by the PIC to maintain the

desired liquid level in the cooler (as is done for Non-Economized chillers). The float valve maintains a liquid level in the bottom of the economizer. Liquid refrigerant is supplied from the condenser to the bottom of the economizer. As the refrigerant passes through the EXV, its pressure is reduced to an intermediate level of about 500 kPa. This pressure is maintained inside the economizer shell. Next, the refrigerant flows through the float valve, its pressure is further reduced to slightly above the pressure in the cooler. The increase in performance is realized when some of the refrigerant passing through the EXV flashes to vapor, further subcooling the liquid that is maintained at the bottom of the economizer. This increase in subcooling provides additional capacity. Since no additional power is required to accomplish this, the efficiency of the machine also improves. The vapor that flashes will rise to the economizer where it passes to the compressor and is used as needed to provide motor cooling. After passing over the motor windings, the refrigerant reenters the cycle at an intermediate port in the compression cycle.

#### 14.7 - Oil pumps

The 30GX/HXC screw chillers use one externally mounted pre-lubricating oil pump per circuit. This pump is operated as part of the start-up sequence.

**ATTENTION:** *The operating temperature of the coil may reach 80°C. In certain temporary conditions (especially during start-up at low outside temperature or low condenser loop temperature) the oil pump can be reactivated.*

On 30GX units, the pumps are mounted to the base rails on the oil separator side of the unit. The pumps are mounted to a bracket on the condensers of 30HXC units. When a circuit is required to start, the controls will energize the oil pump first so that the compressor starts with correct lubrication. If the pump has built up sufficient oil pressure, the compressor will be allowed to start. Once the compressor has started, the oil pump will be turned off. If the pump was not able to build up enough oil pressure, the control will generate an alarm.

#### 14.8 - Motor cooling valves

Compressor motor winding temperatures are controlled to the optimum setpoint. The control accomplishes this by cycling the motor cooling solenoid valve to allow liquid refrigerant to flow across the motor windings as needed. On units equipped with economizers, flash gas leaves the top of the economizer and continually flows to the motor windings. All refrigerant used for motor cooling re-enters the rotors through a port located midway along the compression cycle and is compressed to discharge pressure.

#### 14.9 - Sensors

The units use thermistors (including two motor temperature thermistors) and two level thermistors and pressure transducers to monitor and control system operation.

### 14.10 - Thermistors

#### 14.10.1 - Evaporator leaving fluid

This temperature is used to measure the leaving evaporator fluid temperature (water or brine). The temperature is used for leaving fluid temperature control and to protect against cooler freeze-up. It is located in the evaporator fluid nozzle.

#### 14.10.2 - Evaporator entering fluid

This sensor is used to measure the evaporator entering fluid temperature. It is located in the entering evaporator nozzle. It is used to provide automatic temperature compensation for the leaving fluid temperature control with entering fluid compensation.

#### 14.10.3 - Discharge gas temperature (circuits A & B)

This sensor used to measure the discharge gas temperature and control the discharge temperature superheat. It is located on the discharge pipe of each circuit (30HXC) or on the top of the oil separator (30GX).

**ATTENTION:** *There is no thermostat sleeve.*

#### 14.10.4 - Motor temperature

The Compressor Protection Module (CPM) monitors the motor temperature. Thermistor terminals are located in the compressor junction box.

#### 14.10.5 - Evaporator liquid level (circuits A & B)

Evaporator liquid level thermistor is used to provide optimized flow control in the evaporator. It is installed in the top of the evaporator.

#### 14.10.6 - Condenser entering fluid (30HXC)

This sensor is used to measure the temperature of the fluid entering the water cooled condensers. It is located in the common fluid line entering the condensers (field installed). On Heat Machines it is used by the capacity control routine. On water cooled condensers it is only used for monitoring of the condenser fluid temperature.

#### 14.10.7 - Condenser leaving fluid (optional on 30HXC)

This sensor is used to measure the temperature of the fluid leaving the water cooled condensers. It is located in the common fluid line leaving the condensers (field installed). On Heat Machines it is used by the capacity control routine. On water cooled condensers it is only used for monitoring of the condenser fluid temperature.

14.11 - 30GX fan arrangement

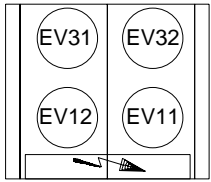

GX082/102

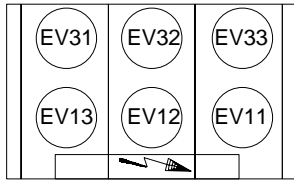

GX112/132

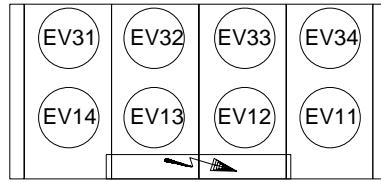

GX152/162

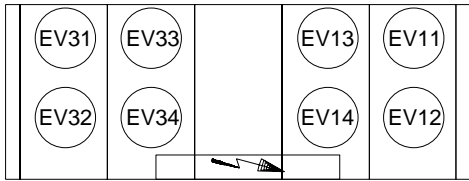

GX182

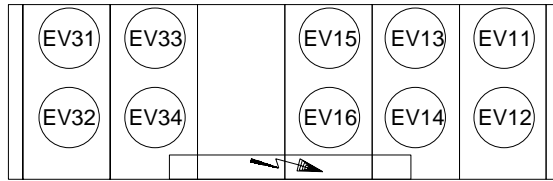

GX207/227

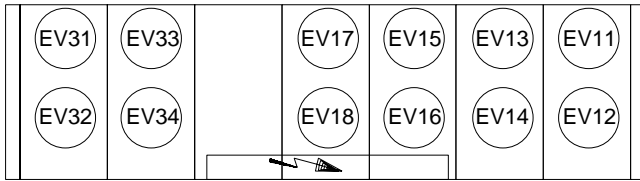

GX247/267

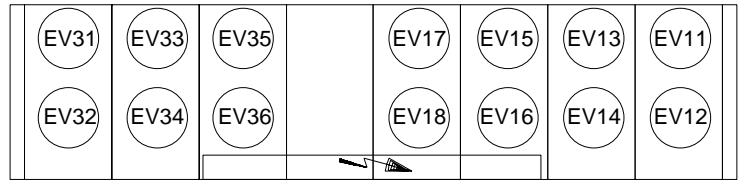

GX298

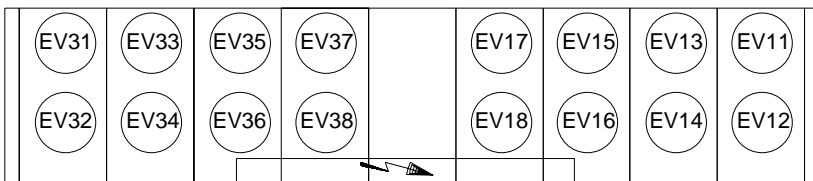

GX328/358

## 15 - MAINTENANCE

### 15.1 - Refrigerant charging - adding charge

#### **IMPORTANT**

*These units are designed for use with R-134a only. DO NOT USE ANY OTHER refrigerant in these units.*

#### **CAUTION**

*When adding or removing charge, circulate water through the condenser (HX) and cooler at all times to prevent freezing. Freezing damage is considered abuse and may void the Carrier warranty.*

#### **CAUTION**

*DO NOT OVERCHARGE system. Overcharging results in higher discharge pressure with higher cooling fluid consumption, possible compressor damage and higher power consumption.*

### 15.2 - Indication of low charge on a 30HXC system

#### **NOTE**

*To check for low refrigerant charge on a 30HXC, several factors must be considered. A flashing liquid-line sightglass is not necessarily an indication of inadequate charge. There are many system conditions where a flashing sightglass occurs under normal operation. The 30HXC metering device is designed to work properly under these conditions.*

1. Make sure that the circuit is running at a full-load condition. To check whether circuit A is fully loaded, follow the procedure described in the Controls manual.
2. It may be necessary to use the Manual Control feature to force the circuit into a full-load condition. If this is the case, see the instructions for using the Manual Control feature in the Controls manual.
3. With the circuit running at full-load, verify that the cooler leaving fluid temperature is in the range of  $6^{\circ}\text{C} \pm 1.5$ .
4. At this condition, observe the refrigerant in the liquid line sightglass. If there is a clear sightglass, and no signs of flashing, then the circuit is adequately charged. Skip the remaining steps.
5. If the refrigerant appears to be flashing, the circuit is probably low on charge. Verify this by checking the EXV position (see Controls IOM).
6. If the opening position of the EXD is greater than 60%, and if the liquid-line sightglass is flashing, then the circuit is low on charge. Follow the procedure for adding charge.

#### **15.2.1 - To add charge to the 30HXC systems**

1. Make sure that the unit is running at full-load, and that the cooler leaving fluid temperature is in the range of  $5.6 - 7.8^{\circ}\text{C}$ .
2. At these operating conditions, check the liquid-line sightglass. If there is a clear sightglass, then the unit has sufficient charge. If the sightglass is flashing, then check the EXD Percent Open. If this is greater than 60%, then begin adding charge.

#### **NOTE**

*A flashing liquid-line sightglass at operating conditions other than those mentioned above is not necessarily an indication of low refrigerant charge.*

3. Add 2.5 kg of liquid charge into the evaporator using the charging valve located on the top of the evaporator.
4. Observe the EXD Percent Open value. The EXD should begin closing as charge is being added. Allow the unit to stabilize. If the EXD Percent Open remains above 60%, and there are still bubbles in the sightglass, add an additional 2.5 kg of liquid charge.
5. Allow the unit to stabilize, and again check the EXD Percent Open. Continue adding 2.5 kg of liquid refrigerant charge at a time, and allow the unit to stabilize before checking the EXD position.
6. When the EXD Percent Open is in the range of 40 - 60%, check the liquid line sightglass. Slowly add enough additional liquid charge to ensure a clear sightglass. This should be done slowly to avoid overcharging the unit.
7. Verify adequate charge by continuing to run at full-load with  $6^{\circ}\text{C} \pm 1.5$  evaporator leaving fluid temperature. Check that the refrigerant is not flashing in the liquid-line sightglass. The EXD Percent Open should be between 40 and 60%. The cooler level indicator should be in the range of 1.5 - 2.5.

#### **15.2.2 - Indication of low charge on 30GX systems**

1. Make sure that the circuit is running at a full-load condition and that the condensing temperature is  $50^{\circ}\text{C} \pm 1.5$ . To check whether circuit A is fully-loaded, follow the procedure in the Controls IOM.
2. It may be necessary to use the Manual Control feature to force the circuit into a full-load condition. If this is the case, see the instructions for using the Manual Control function (procedure in the Controls IOM).
3. With the circuit running at full-load, verify that the cooler leaving fluid temperature is in the range of  $6^{\circ}\text{C} \pm 1.5$ .
4. Measure the air temperature entering the condenser coils. Measure the liquid temperature after the tee where the two coil liquid lines join. The liquid temperature should be  $8.3^{\circ}\text{C}$  above the air temperature entering the coils. If the difference is more than this and the sightglass is flashing, the circuit is uncharged. Proceed to step 5.
5. Add 2.5 kg of liquid charge into the cooler using charging valve located in the top of the cooler.
6. Allow the system to stabilize and then recheck the liquid temperature. Repeat step 5 as needed allowing the system to stabilize between each charge addition. Slowly add charge as the sightglass begins to clear to avoid overcharging.

#### **15.2.3 - Space temperature, outdoor air temperature (optional)**

These temperatures are used to measure the temperature of the space or the outside air temperature respectively for reset control based on Outside Air or Space Temperature reset options.

## 15.3 - Pressure transducers

### 15.3.1 - Discharge pressure (circuits A & B)

This input is used to measure the high side pressure of each circuit of the unit.

**It is used to provide the pressure to replace the discharge pressure gauge and to control the head pressure.**

### 15.3.2 - Suction pressure (circuits A & B)

This input is used to measure the pressure of the low side of the unit. It is used to provide the pressure to replace the suction pressure gauge.

### 15.3.3 - Oil pressure (each compressor)

This input is used to measure the oil pressure of each compressor of the unit. It is located on the oil pressure port of each compressor.

### 15.3.4 - Economizer pressure (circuits A & B)

This input is used to monitor the oil pressure differential supplied to the compressor.

## 15.4 - Oil charging - low oil recharging

### 15.4.1 - Addition of oil charge to 30HX/GX systems

1. If the 30HXC/GX unit shuts-off repeatedly on Low oil Level, this may be an indication of inadequate oil charge. It could also mean simply that oil is in the process of being reclaimed from the low-side of the system.
2. Begin by running the unit at full-load for an hour and a half.
3. After running for 1-1/2 hours allow the unit to re-start and run normally. If the Low Oil Level alarms persist, the unit has a low oil charge. Add oil to the oil separator, using the oil charging valve at the bottom of the condenser (30HXC) or at the bottom of the oil separator (30GX).

### **CAUTION**

**Do NOT add oil at any other location as improper unit operation may result.**

4. Make sure that the unit is not running when adding oil, as this will make the oil charging process easier. Because the system is under pressure even when the unit is not running, it will be necessary to use a suitable pump (hand or electric pump) to add oil to the system.
5. Using a suitable pump, add 2 litres of Polyolester oil to the system (CARRIER SPEC: PP47-32). Make sure that the oil level safety switch is NOT jumpered, and allow the unit to re-start and run normally.
6. If low oil level problems persist, add another 1 or 2 litres of oil. If it is necessary to add more than 4 litres of oil to the system, then contact your Carrier distributor service department.

**CAUTION: When transferring the refrigerant charge to a storage unit, oil may be carried along when the unit is not operating. Reuse first of all the amount of refrigerant transferred. After draining the oil, only recharge the amount drained (an excess oil charge may impair correct unit operation).**

## 15.5 - Integral oil filter change

An integral oil filter in the 06N screw compressor is specified to provide a high level of filtration (3  $\mu$ ) required for long bearing life. As system cleanliness is critical to reliable system operation, there is also a prefilter (7  $\mu$ ) in the oil line at the oil separator outlet.

The replacement integral oil filter element part number is:

Carrier part number (including filter and O-ring):  
06NA 660016S

## 15.6 - Filter change-out schedule

The filter should be checked after the first 500 hours of operation, and every subsequent 2000 hours. The filter should be replaced at any time when the pressure differential across the filter exceeds 2.1 bar.

The pressure drop across the filter can be determined by measuring the pressure at the filter service port and the oil pressure port. The difference in these two pressures will be the pressure drop across the filter, check valve, and solenoid valve. The pressure drop across the check valve and solenoid valve is approximately 0.4 bar, which should be subtracted from the two oil pressure measurements to give the oil filter pressure drop. The oil filter pressure drop should be checked after any occasion that the compressor is shut down on a low oil pressure safety.

## 15.7 - Filter change-out procedure

The following steps outline the proper method of changing the integral oil filter.

1. Shutdown and lockout the compressor.
2. Manually force the operation of the oil solenoid valve, in order to press the internal valve shutter onto its seat.
3. Close the oil filter service valve. Bleed pressure from the filter cavity through the filter service port.
4. Remove the oil filter plug. Remove the old oil filter.
5. Prior to installing the new oil filter, "grease" the o-ring with oil. Install the filter and replace the plug.  
Before closing up the lube oil system, take the opportunity to replace the prefilter, as well.
6. When complete, evacuate the filter cavity through the filter service port. Open the filter service valve. Remove any compressor lockout devices, the compressor is ready to return to operation.

## 15.8 - Compressor replacement

### 15.8.1 - Compressor rotation control

Correct compressor rotation is one of the most critical application considerations. Reverse rotation, even for a very short duration, damages the compressor.

The reverse rotation protection scheme must be capable of determining the direction of rotation and stopping the compressor within 300 milliseconds. Reverse rotation is most likely to occur whenever the wiring to the compressor terminals is disturbed.

To minimize the opportunity for reverse rotation, the following procedure must be applied. Rewire the power cables to the compressor terminal pin as originally wired.

For replacement of the compressor, a low pressure switch is included with the compressor. This low pressure switch should be temporarily installed as a hard safety on the high pressure part of the compressor. The purpose of this switch is to protect the compressor against any wiring errors at the compressor terminal pin. The electrical contact of the switch would be wired in series with the high pressure switch. The switch will remain in place until the compressor has been started and direction of rotation has been verified; at this point, the switch will be removed.

The switch that has been selected for detecting reverse rotation is Carrier part number HK01CB001. It is available as part of the "Compressor installation package" (part No. 06NA 660 013). This switch opens the contacts when the pressure falls below 50 mm of vacuum. The switch is a manual reset type that can be reset after the pressure has once again risen above 70 kPa. It is critical that the switch be a manual reset type to preclude the compressor from short cycling in the reverse direction.

## 15.8.2 - EXD Troubleshooting Procedure

### Follow steps below to diagnose and correct EXD/Economizer problems.

On 30HXC/GX units with economizers, verify that the valve for the bubbler tube (bottom of Economizer) is open. Check EXD motor operation first (see procedure in the Controls IOM). You should be able to feel the actuator moving by placing your hand on the EXD or economizer body (the actuator is located about one-half to two-thirds of the way up from the bottom of the economizer shell). You should feel a hard knocking come from the actuator when it reaches the top of its stroke (can be heard if surroundings are relatively quiet). The actuator should knock when it reaches the bottom of its stroke. If it is believed that the valve is not working properly, contact your Carrier service department for further checks on:

- output signals on EXD module
- wire connections (continuity and tight connection at all pin terminals)
- resistance of the EXD motor windings.

**16 - START-UP CKECKLIST FOR 30HXC/GX LIQUID CHILLERS (USE FOR JOB FILE)**

**Preliminary information**

Job name: .....  
Location: .....  
Installing contractor: .....  
Distributor: .....  
Start-up preformed by: .....

**Compressors**

Model: ..... S/N .....

**Compresseurs**

<u>Circuit A</u>	<u>Circuit B</u>
1. Model # .....	1. Model # .....
S/N .....	S/N .....
Mtr # .....	Mtr # .....
2. Model # .....	2. Model # .....
S/N .....	S/N .....
Mtr # .....	Mtr # .....

**Cooler**

Model # ..... Manufactured by .....  
S/N ..... Date .....

**Condenser (30HXC)**

Model # ..... Manufactured by .....  
S/N ..... Date .....

**Air handling equipment**

Manufacturer .....  
Model # ..... S/N .....

Additional air handling units and accessories .....

**Preliminary equipment check**

Is there any shipping damage ? ..... If so, where ? .....  
Will this damage prevent unit start-up ? .....

- Unit is level in its installation
- Power supply agrees with the unit nameplate
- Electrical circuit wiring has been sized and installed properly
- Unit ground wire has been connected
- Electrical circuit protection has been sized and installed properly
- All terminals are tight
- All cables and thermistors have been inspected for crossed wires
- All plug assemblies are tight

**Check air handling systems**

- All air handlers are operating
- All chilled water valves are open
- All fluid piping is connected properly
- All air has been vented from the system
- Chilled water pump (CWP) is operating with the correct rotation. CWP amperage: Rated: ..... Actual.....



**Check condenser system (30HXC)**

- All condenser water valves are open
- All condenser piping is connected properly
- All air has been vented from the system
- Condenser water pump (CWP) is operating with the correct rotation.  
Condenser water pump amperage: Rated:..... Actual.....

**Unit start-up**

- CWP starter has been properly interlocked with the chiller
- Oil heaters have been energized for at least 24 hours (30GX)
- Oil level is correct
- All discharge and liquid valves are open
- All suction valves are open, if equipped
- All oil line valves and economizer discharge bubbler valves (30HXC only if equipped) are open
- Unit has been leak checked (including fittings)  
Locate, repair, and report any refrigerant leaks

.....  
 .....  
 .....

Check voltage imbalance: AB ..... AC ..... BC .....  
 Average voltage = ..... (see installation instructions)  
 Maximum deviation = ..... (see installation instructions)  
 Voltage imbalance = ..... (see installation instructions) .

- Voltage imbalance is less than 2%

**WARNING**

*Do not start chiller if voltage imbalance is greater than 2%. Contact local power company for assistance.*

- All incoming power voltage is within rated voltage range

**Check cooler water loop**

Water loop volume = ..... (liters)  
 Calculated volume = ..... (liters)  
 3.25 liters/nominal kW capacity for air conditioning  
 6.5 liters/nominal kW capacity for process cooling

- Proper loop volume established
- Proper loop corrosion inhibitor included ..... liters of .....
- Proper loop freeze protection included (if required) ..... liters of .....
- Piping includes electric heater tape, if exposed to the outside
- Inlet piping to cooler includes a 20 mesh strainer

**Check pressure drop across the cooler**

Entering cooler = ..... (kPa)  
 Leaving cooler = ..... (kPa)  
 (Leaving - entering) = ..... (kPa)

**WARNING**

*Plot cooler pressure drop on performance data chart (in product data literature) to determine total liters per second (l/s) and find unit's minimum flow rate.*

Total l/s = .....  
 l/s / nominal kW = .....

- Total l/s is greater than unit's minimum flow rate
- Total l/s meets job specified requirement of ..... (l/s)

**Check condenser water loop**

- Proper loop corrosion inhibitor included ..... liters of .....
- Inlet piping to condenser includes a 20 mesh strainer

**Check pressure drop across the condenser (30HXC only)**

Entering condenser = ..... (kPa)

Leaving condenser = ..... (kPa)

(Leaving - entering) = ..... (kPa)

**WARNING**

*Plot condenser pressure drop on performance data chart (in product data literature) to determine total liters per second (l/s) and find unit's minimum flow rate.*

Total l/s = .....

l/s / nominal kW = .....

Total l/s is greater than unit's minimum flow rate

Total l/s meets job specified requirement of ..... (l/s)

**Perform TEST function (indicate positive result):**

**WARNING**

*Once power is supplied to the unit, check the display for any alarms, such as phase reversal. Follow the TEST function instructions in the Controls and Troubleshooting literature (follow the procedure in the Controls IOM).*

*Be sure all service valves are open before beginning the compressor test section.*

- Cooler fluid select ..... External reset sensor .....
- Minimum load select ..... Cooler pump interlock .....
- Loading sequence select ..... Cooler pump control .....
- Lead/lag sequence select ..... Condenser pump control\* .....
- Head pressure control ..... Condenser flow switch\* .....
- Motormaster select\* ..... Condenser water sensors\* .....
- Water valve type\* ..... \*If installed

**To start the chiller**

**WARNING**

*Be sure that all service valves are open, and all pumps are on before attempting to start this machine. Once all checks have been made, move the switch to "LOCAL" or "REMOTE" from "OFF".*

Unit starts and operates properly

**Temperatures and pressures**

**WARNING**

*Once the machine has been operating for a while and the temperatures and pressures have stabilized, record the following*

- Cooler EWT ..... Ambient temperature (GX) .....
- Cooler LWT ..... Condenser EWT .....
- ..... Condenser LWT .....

- Circuit A oil pressure ..... Circuit B oil pressure .....
- Circuit A suction pressure ..... Circuit B suction pressure .....
- Circuit A discharge temperature ..... Circuit B suction temperature .....
- Circuit A suction temperature ..... Circuit B discharge pressure .....
- Circuit A discharge pressure ..... Circuit B discharge temperature .....
- Circuit A liquid line temperature ..... Circuit B liquid line temperature .....

**NOTES:**

.....

.....

.....

.....

.....





Order No: 13173-76, 03 1999 - Supersedes No: 13173-76, March 1998  
Manufacturer reserves the right to change any product specifications without notice.



Environmental Management System Approval

Manufacturer: Carrier s.a., Montluel, France.  
Printed in the Netherlands on chlorine-free paper.